





TRYMAX SURGICAL



CATALOGUE

-  BASIC ORTHOPEDIC INSTRUMENTS
-  SPINAL INSTRUMENTS
-  TRAUMA INSTRUMENTS

INDEX

<u>PARTICULARS</u>	<u>PAGE</u>
1) ORTHOPEDIC DRESSING – PLASTER INSTRUMENTS	03-05
2) AMPUTATION SAW – GIGLI SAW	06-07
3) REAMERS – AWLS – BONE HOOKS	08-09
4) ORTHOPEDIC HAND BONE DRILLS & ACCESSORIES	10-03
5) BONE HOLDING CLAMPS – TRACTION BARS	14-15
6) VISE GRIPS – NOSE PLIERS – SLAP HAMMERS	16-17
7) NOSE PLIERS – PULLING FORCEPS – WIRE CUTTERS	18-20
8) PLIERS – BENDERS – ROD INSTRUMENTS	21-22
9) WIRE INSTRUMENTS – EXTENSION BOWS	23-25
10) RING CUTTERS – LEAD HANDS – BIPOSY TOOLS	26-27
11) BONE TEMPERS – IMPACTORS - PACKERS	28
12) BONE RASPS – FILES	29-32
13) BONE LEVERS – RETRACTORS	33-39
14) CHISELS – OSTEOTOMES – GOUGES	40-45
15) BONE CURETTES	46-51
16) PERIOSTEAL ELEVATORS – DISSECTORS	52-56
17) ORTHOPEDIC MALLETS & ELEVATORS SPINAL S/S & SPINAL	58-60
18) TENDON INSTRUMENTS	61-64
19) PELVIC REDUCTION FORCEPS	65-66
20) BONE HOLDING FORCEPS	67-74
21) REPOSITION – CARTILAGE FORCEPS	75
22) BONE CUTTING FORCEPS	76-79
23) BONE RONGEURS – NIBBLERS	80-90
24) RIB SHEARS	91-92
25) LAMINA SPREADERS – RETRACTORS	93-94
26) CALCANEAL LAMBARDI SPREADERS	95
27) COMPRESSORS - DISTRACTORS	96-97
28) ROD BENDERS	98
29) CARBIDE WIRE – PIN CUTTING PLIERS	99-102
30) CARBIDE INSERTED SURGICAL SCISSORS	103-104
31) INSTRUMENTS FOR TRUATOMY	105-117

TS-S-1001

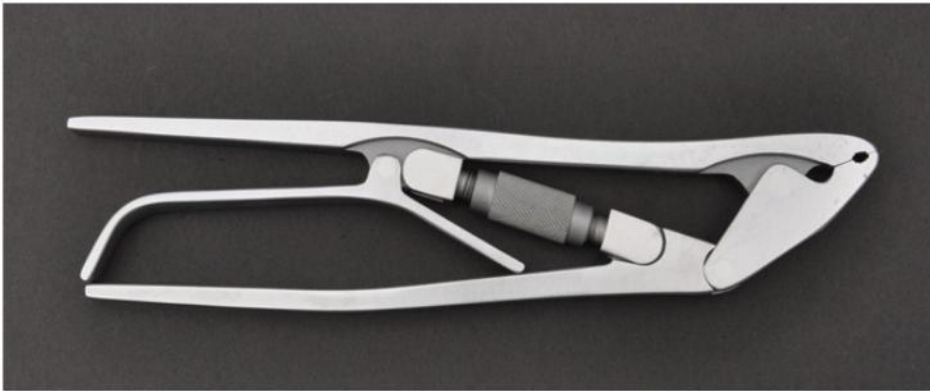

TS-S-1002



TS-S-1005



TS-S-1007



TS-S-1008

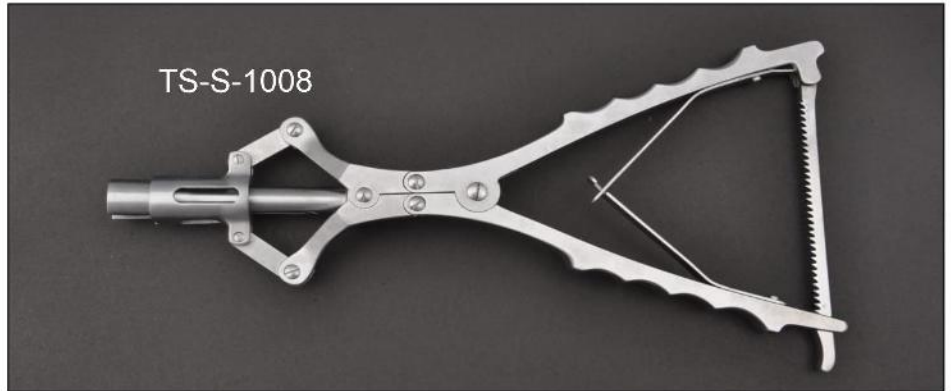

TS-S-1051



TS-S-1052



TS-S-1053



TS-S-1055



TS-S-1054



ORTHOPEDIC DRESSING – PLASTER INSTRUMENTS

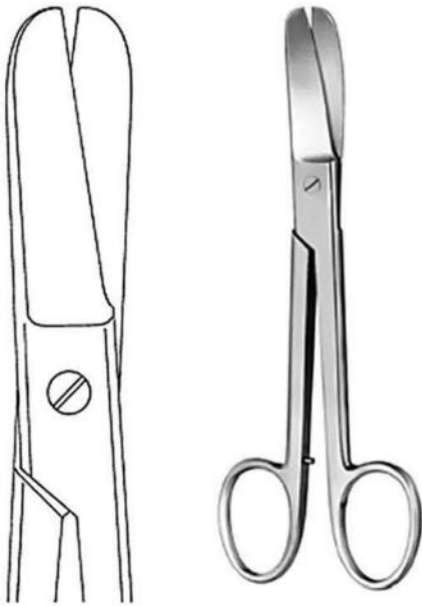

11-01-0300

Lorenz Bandage Scissors
Heavy Pattern 23 cm / 9"

Also available
in 18.5 cm / 7 1/4"
& 20 cm / 8"

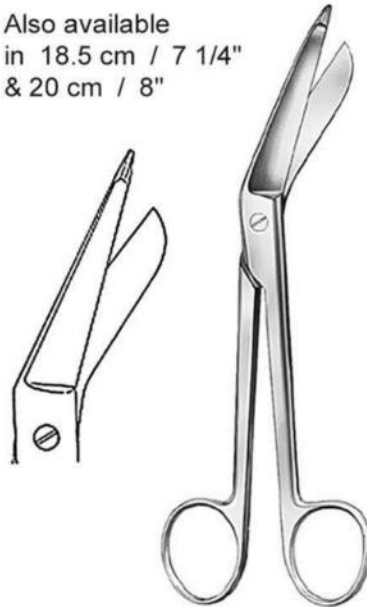

11-01-0301

Lister Bandage Scissors
14.5 cm / 5 3/4"

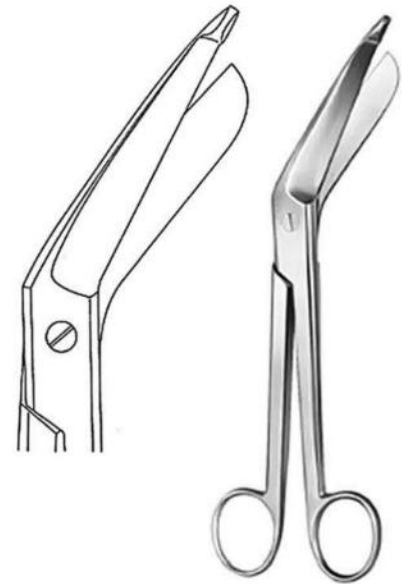

11-01-0302

Bergmann Plaster Shears
Heavy Pattern 23.5 cm / 9"



11-01-0303

Esmarch Plaster Shears
Heavy Pattern, Short Blades
20 cm / 8"

Also available
in 18cm / 7 1/2"



11-01-0304

Bandage Scissors
16cm / 6 1/4" Black Plastic Rings



11-01-0305

Bruns Plaster Scissors 24 cm
9 1/2" One Serrated Cutting Edge

ORTHOPEDIC DRESSING – PLASTER INSTRUMENTS



Also Available
26 cm / 10"
38 cm / 15"

11-01-0306

Stille-Martin Plaster Shears
23 cm / 9"



11-01-0307

Engel Plaster Saw 15.5 cm / 6"



11-01-0308A

Engel Plaster Saw 15.5 cm / 6"



11-01-0308B

Bergmann Plaster Saw 18 cm / 7"



11-01-0309 Reiner Plaster Knife 18 cm / 7"



11-01-0311 Hopkins Plaster Knife 20 cm / 8"



11-01-0310 Esmarch Plaster Knife 18 cm / 7"



with wooden handle

11-01-0312 Martin Plaster Knife 21 cm / 8 ¼"

ORTHOPEDIC DRESSING – PLASTER INSTRUMENTS

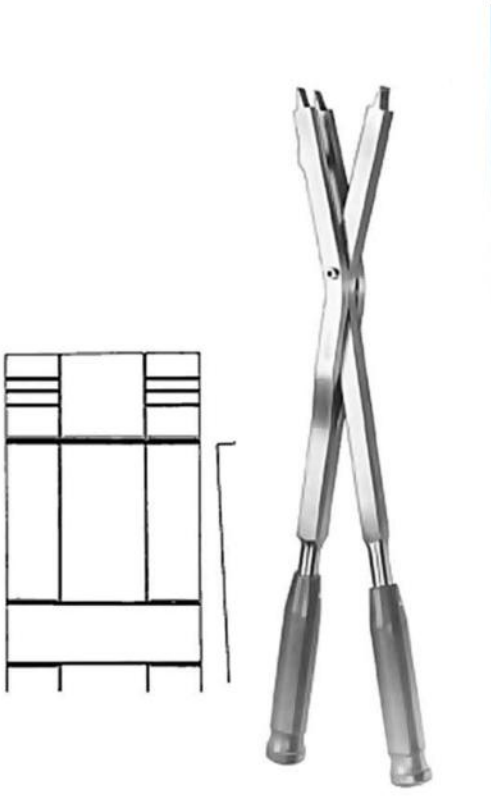

11-01-0313

Hermann Plaster Spreader
48 cm / 19" Heavy Pattern



11-01-0314

Hennig Plaster Spreader
28 cm / 11"



11-01-0315

Hennig Plaster Spreader
30 cm / 12"



11-01-0316 Beeson Plaster Spreader 1.5 in Blade 30 cm / 12"

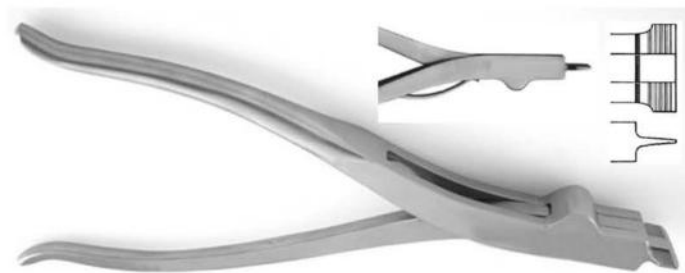

11-01-0317 Walton Plaster Spreader w/Spring 3 Prongs 23 cm / 9"



11-01-0318

Wolff Plaster Breaker
A: 18 cm / 7"
B: 26.5 cm / 10 1/2"

AMPUTATION SAW – GIGLI SAW

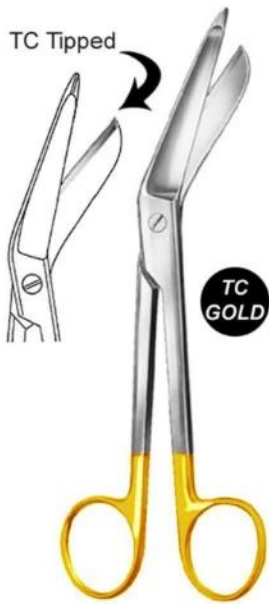

11-01-0319
Lister Bandage Scissors TC
18 cm / 7" cm / 13 3/4"



11-01-0320
Bruns Plaster Scissors
24 cm / 9 1/2"



11-01-0321
Charriere Amputation Saw 35 cm / 13 3/4"



A: 21.5 cm / 8 3/4" 12mm



B: 21.5 cm / 8 3/4" 15mm



C: 21.5 cm / 8 3/4" 18mm

Spare Saw Blades



11-01-0322
BIER Amputation Saw 40.5 cm / 16"



A: 27 cm / 10 3/4" 4 mm wide



B: 27 cm / 10 3/4" 6 mm wide



C: 27 cm / 10 3/4" 8 mm wide



11-01-0323
Langenbeck Amputation Saw 24.5 cm / 9 3/4"



11-01-0324 Satterlee Amputation Saw
29 cm / 11 1/2"



11-01-0325 Charriere Amputation Saw 27 cm / 10 1/2"



11-01-0326 Satterlee Amputation Saw 23 cm / 9"

AMPUTATION SAW – GIGLI SAW

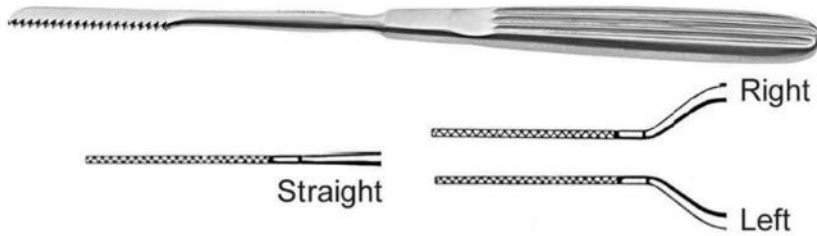

11-01-0327 Joseph Amputation Saw 18 cm / 7"

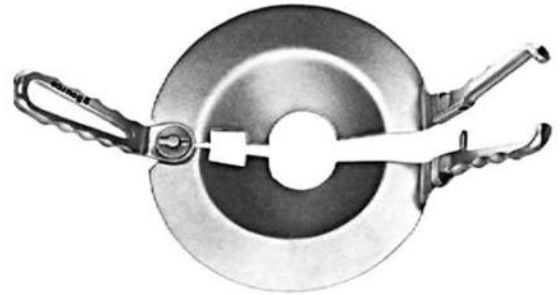

11-01-0328

Percy Amputation Shield 30 cm / 12"



11-01-000

- A:** Gigli Saw 30cm
- B:** Gigli Saw 50cm
- C:** Tyler Gigli Saw (Large Cut) 30cm
- D:** Tyler Gigli Saw (Large Cut) 30cm

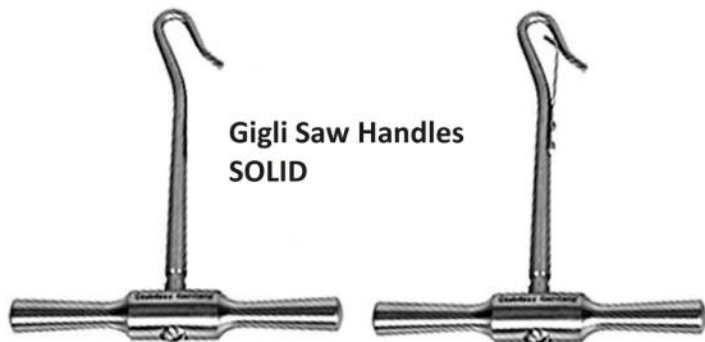

**Gigli Saw Handles
SOLID**

11-01-001 Gigli Sold in Pair

11-01-002 Gigli Sold in Pair



11-01-005 BAILEY GIGLI SAW GUIDE 30 CM

11-01-006 POPPEN GIGLI SAW GUIDE 28 CM



**Gigli Saw Handles
SOLID**

11-01-003 Gigli Sold in Pair

11-01-004 Gigli Sold in Pair



REAMERS - AWLS - BONE HOOKS



11-01-0329
Reamer
13.5cm / 5 1/4"



11-01-0330
Perthes Reamer
18 cm / 7"



11-01-0331
Perthes Reamer
21.5 cm / 8 1/2"



11-01-0332
Reamer One concave
side 14 cm / 5 1/2"

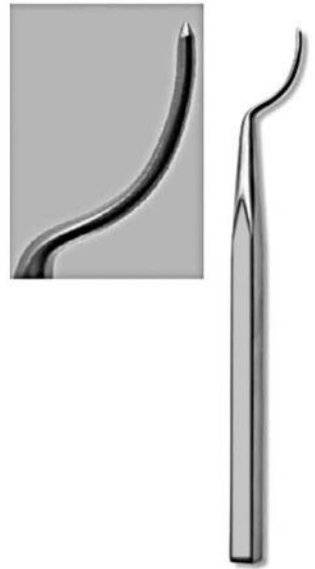

11-01-0333
Glenoid Punch
20 cm / 8"

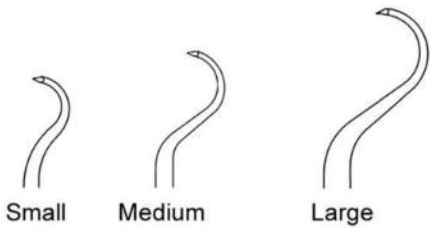

11-01-0334
Shoulder Percussion Awl **A:** 21.5cm / 8 1/2" **B:** 23.5cm / 9 1/4"



A: 20cm / 8"
19X27mm
Sharp

B: 23cm / 9"
15X20mm
Blunt

C: 23cm / 9"
15X20mm
Sharp

C: 25cm / 9 3/4"
15X20mm
Sharp

11-01-0335 Volkman Bone Hook

REAMERS - AWLS - BONE HOOKS



11-01-0336

Kuntscher Diamond Awl 28 cm / 11"

Pointed

11-01-0337

Rush Awl / Reamer

A: 19 cm / 7 1/2" 2.5mm

B: 21 cm / 8 1/4" 3mm

C: 21 cm / 8 1/2" 5mm

D: 26 cm / 10 1/2" 6mm

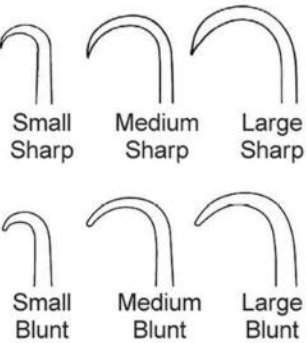
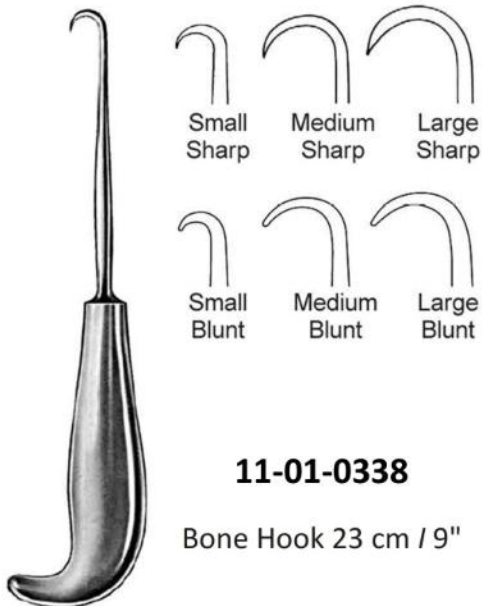

11-01-0338

Bone Hook 23 cm / 9"

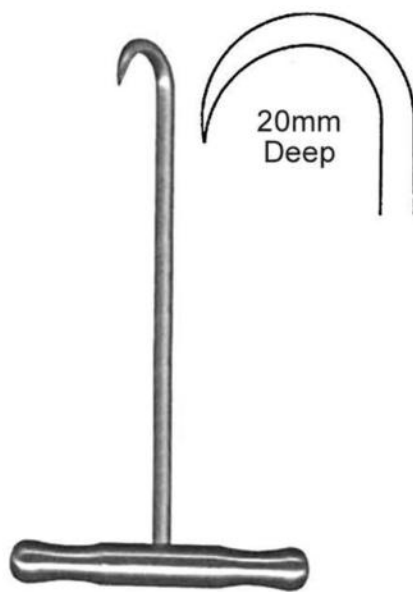

11-01-0339

Bone Hook T Handle 20 cm / 8"



11-01-0340

Bone Hook T Fiber Handle 14cm / 5 5/8"

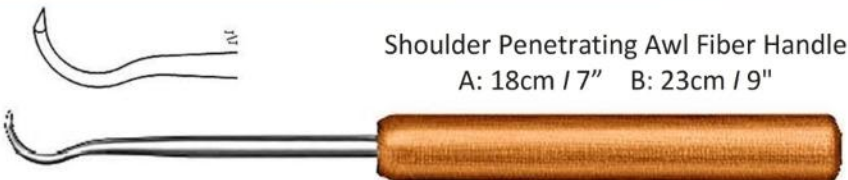

Shoulder Penetrating Awl Fiber Handle

A: 18cm / 7" B: 23cm / 9"

11-01-0341



11-01-0342

Pointed Awl Fiber Handle 25cm / 10"

ORTHOPEDIC HAND BONE DRILLS -ACC

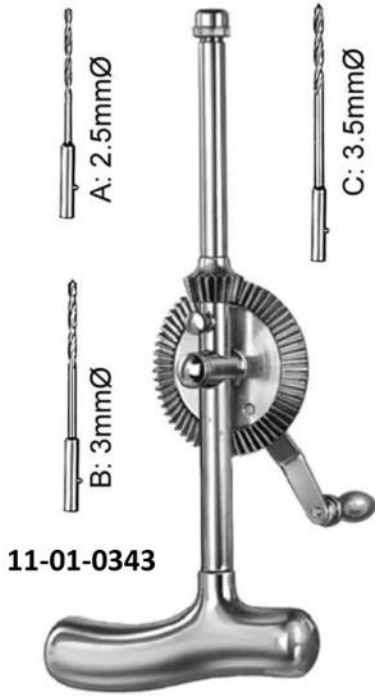

11-01-0343
Stille-Sherman Hand Drill
24 cm / 9 1/2" with 3 twist drills

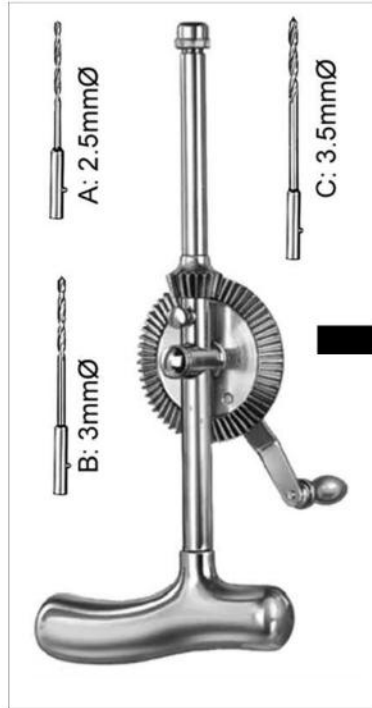

11-01-0344 Stille Hand Drill 20.5 cm / 8" w / 9 Twist Drills

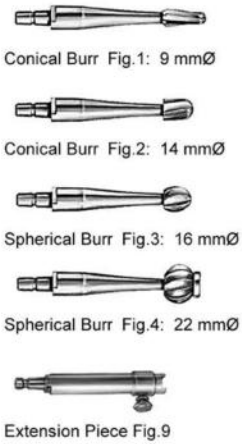
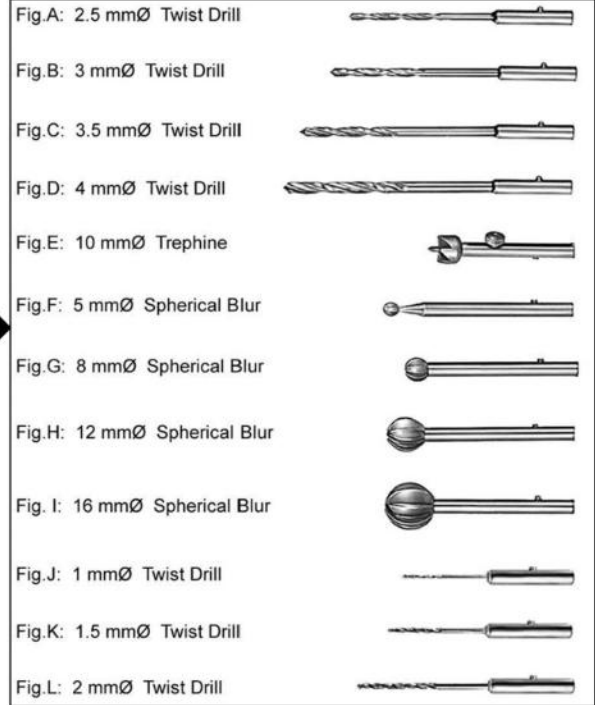

11-01-0345

Hudson Hand Drill
28 cm / 11"
Complete with burs Fig #. 1 - 4
& additional price for additional
accessories

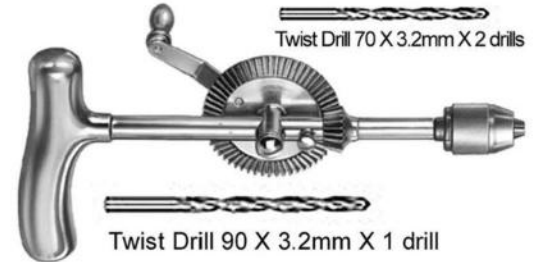
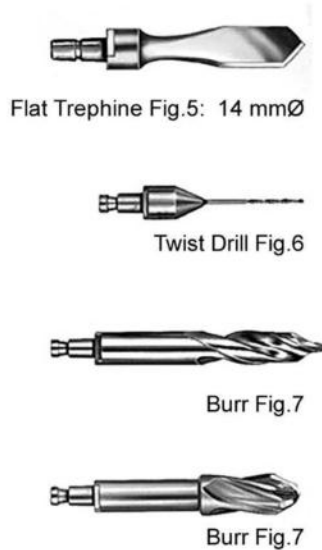

11-01-0346 Moore Hand Drill
Complete with a set of 3 twist drills

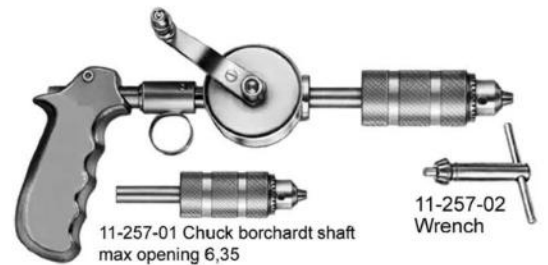

11-01-0347

Martin Hand Drill with Chuck & Wrench

ORTHOPEDIC HAND BONE DRILLS -ACC



11-01-0348
Bunnell Hand Drill
16cm / 6-1/4"

Longitudinally Bored with 3-Jaw-Chuek
Light Metal Housing opening up to 4mm



11-01-0349
Bunnell Hand Drill
16cm / 6-1/4"

Twin Shade Powder Coated Longitudinally
bored with 3-Jaw-Chuek light metal
housing opening up to 4mm

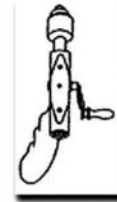

11-01-0350
Ralk Hand Drill

Light Metal Housing
Literally Angled Handle with 3-Jaw-Chuek
and key, opening up to 6,35mm



11-01-0351

HAND DRILL
All Covered Polished / Dull or Coated.
Drills Holder at Bottom.



11-01-0352

Hand Drill
All Covered Light Weight / Polished /
Dull or Coated. Key Holder and Self
Retaining Locking Mechanism



Box for Hand Drills
Outside Artificial Leather
/ inside Jumbo Foam



11-01-0353

Hand Drill
Polished / Dull or Coated. Operated
Horizontally and Vertically



11-01-0354

Hand Drill
Polished / Dull or Coated.
All Covered

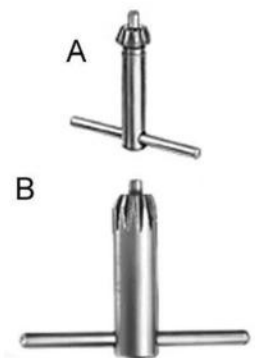

All Hand Drills
Provided with Keys

ORTHOPEDIC HAND BONE DRILLS -ACC



11-01-0355
Hand Drill
Polished / Dull
Or Coated.
Open Housing



11-01-0356
Hand Drill
Polished / Dull
Or Coated.
Open Housing



11-01-0357
Hand Drill
Polished / Dull
Or Coated.
Semi Closed Housing



11-01-0358
Vickers Easidriver 14 Cm / 5 1/2"



11-01-0359
14 cm / 5 1/2"
Handle W/ Chuck Longitudinally
Bored Accommodating up to 3,95mm



11-01-0360
Handle with chuck T-Shaped



11-01-0361
Fiber T-Handle Key



11-01-0362
Key



11-01-0363
Key

ORTHOPEDIC DRILL BITS – BURS - TREPHINES



11-00-01

5mm Borchardt Shaft Twist Drill, Long Working End

A: 2.0mm B: 2.5mm C: 3.0mm D: 3.2mm E: 3.5mm F: 4.0mm G: 5.0mm H: 6.0mm I: 7.0mm



11-00-02

5mm Borchardt Shaft Twist Drill

A: 1.0mm B: 1.5mm C: 1.8mm D: 2.0mm E: 2.2mm F: 2.5mm G: 2.8mm H: 3.0mm I: 3.2mm J: 3.5mm K: 4.0mm L: 5.0mm



11-00-03

5mm Borchardt Shaft Flat Trepine

A: 1.8mm B: 2.0mm C: 2.2mm D: 2.5mm E: 3.0mm F: 3.5mm G: 4.0mm H: 5.0mm



11-00-04

5mm Borchardt Shaft Spherical Burr

A: 3.0mm B: 4.0mm



11-00-05

5mm Borchardt Shaft Spherical Burr

A: 3.0mm B: 5.0mm

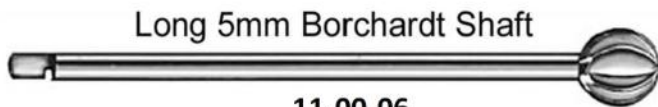

11-00-06

Doyen Spherical Burr

A: 4mm B: 6mm C: 8mm D: 10mm E: 12mm F: 14mm G: 16mm

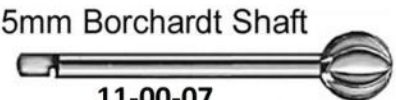

11-00-07

Doyen Spherical Burr

A: 4mm B: 6mm C: 8mm D: 10mm E: 12mm F: 14mm G: 16mm

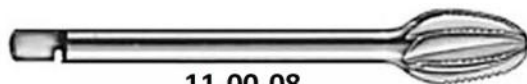

11-00-08

Doyen Conical Burr

Coarse Spacing 12mm Dia

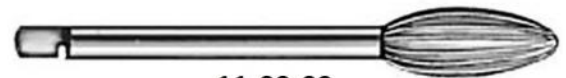

11-00-09

Doyen Conical Burr

Fine Spacing A: 8mm / B: 10mm

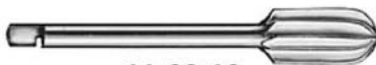

11-00-10

Doyen Cylindrical Burr

Coarse Spacing A: 12mm / B: 15mm



11-00-11

Albee Burr Oval Coarse Spacing

A: 8mm / B: 10mm / C: 12mm



11-00-12

Albee Burr Pointed 7mm



11-00-13

Borchardt Burr Oval Coarse Spacing 13mm



11-00-14

Flat Burr Short Borchardt Shaft 25mm



11-00-15

Toti Trepine Short Borchardt Shaft 8mm

BONE HOLDING CLAMPS – TRACTION BAR



11-01-0364 Gerster-Lowman Bone Holding Clamp

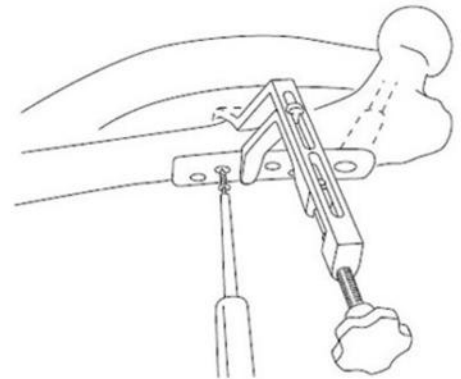
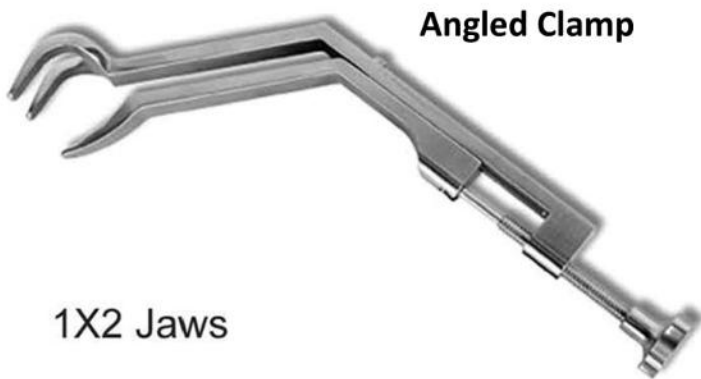
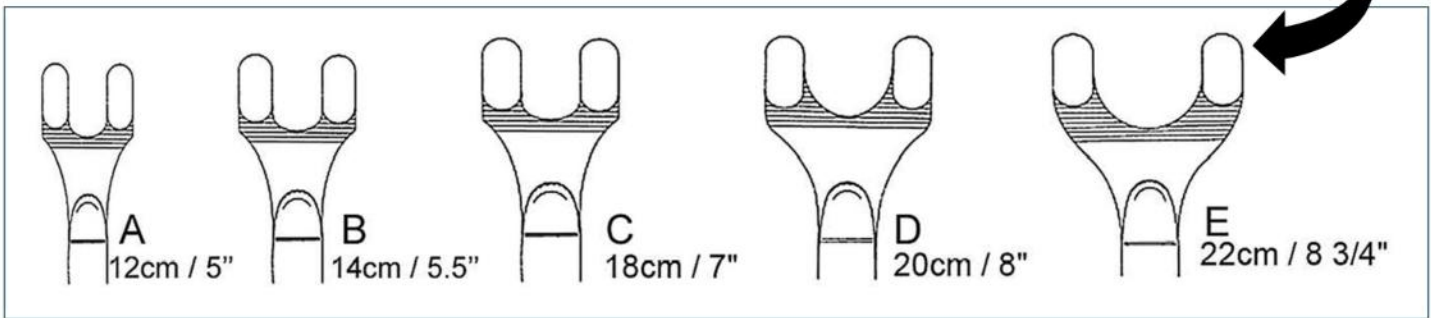

11-01-0365 Gerster-Lowman Bone Holding Clamp

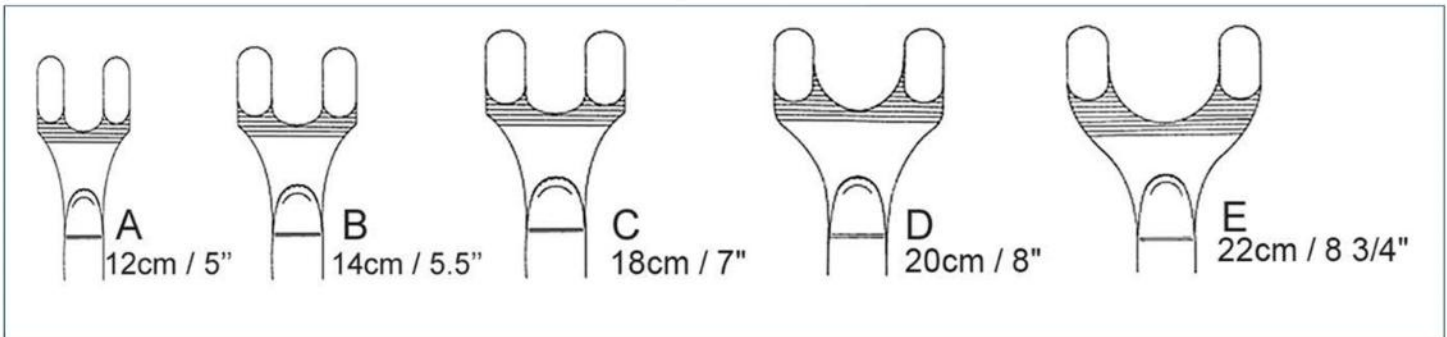

BONE HOLDING CLAMPS – TRACTION BAR



11-01-0366 Gerster Traction bar 15 cm / 6"

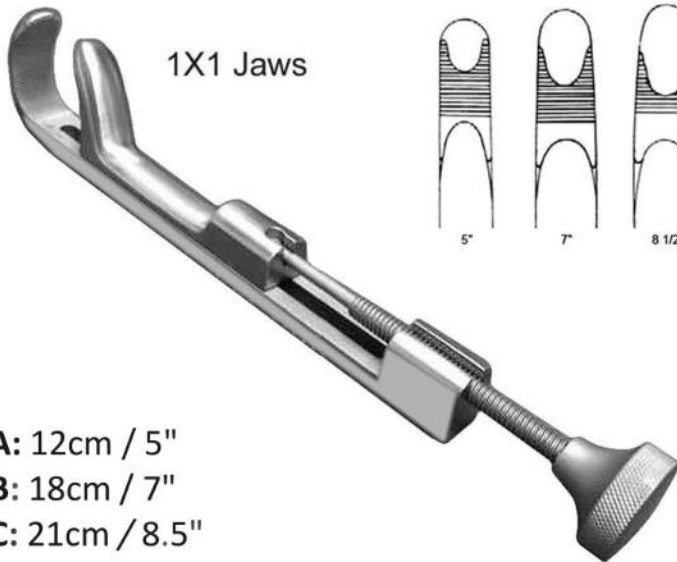

- A: 12cm / 5"
- B: 18cm / 7"
- C: 21cm / 8.5"

11-01-0367
Gerster-Lowman Bone Holding Clamp

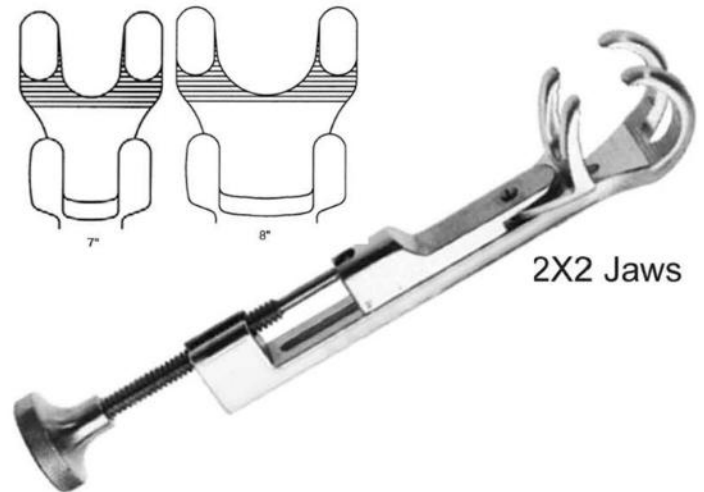

- A: 18cm / 7"
- B: 20cm / 8"

11-01-0368
Gerster-Lowman Bone Holding Clamp

WISE GRIPS – NOSE PLIERS – SLAP HAMMERS [ALL MADE OF STAINLESS STEEL]



11-01-0369
Vise Grip Locking Plier 23 cm / 9"



11-01-0370
Vise Grip Locking Plier 20.5 cm / 8"



11-01-0371
Vise Grip Locking Plier 18 cm / 7"



11-01-0372
Needle Nose Locking Plier 30 cm / 12"



11-01-0373
Needle Nose Locking Plier 25.5 cm / 10"



11-01-0374
Needle Nose Locking Plier 22 cm / 8.5"



11-01-0375
Flat Nose Plier 18.5 cm / 7 1/4" Parallel Grip SS



Max 1.6mm Cutting Capacity

11-01-0376
Flat Nose Plier-Cutter 18.5 cm / 7 1/4" Parallel Grip SS



11-01-0377
Long Nose Plier 22 cm / 8 1/4"



11-01-0378
Vise Grip 20.5 cm / 8" Stainless Steel

VICE GRIPS – NOSE PLIERS – SLAP HAMMERS [ALL MADE OF STAINLESS STEEL]



11-01-0379

Regular Jaw Locking Plier

A: 18 cm / 7" B: 20 cm / 8" C: 23 cm / 9"



11-01-0380

Needle Nose Locking Plier

A: 22 cm / 8.5" B: 25.5 cm / 10" C: 30 cm / 12"



11-01-0381

SLAP HAMMER w/ Threaded Shaft Head



11-01-0382

SLAP HAMMER w/ Hexa Shaft Head



11-01-0383

Combi-Fiat Nose Pliers 15 cm / 6"

For Bending & Cutting



11-01-0385

Flat Nose Plier 13.5 cm / 5 1/4"



11-01-0384

Round / Flat Nose Pliers 18 cm / 7"



with longitudinal groove

11-01-0386

Hackstock Flat Nose Pliers 16 cm / 6 1/4"

NOSE PLIERS – PULLING FORCEPS – WIRE CUTTERS

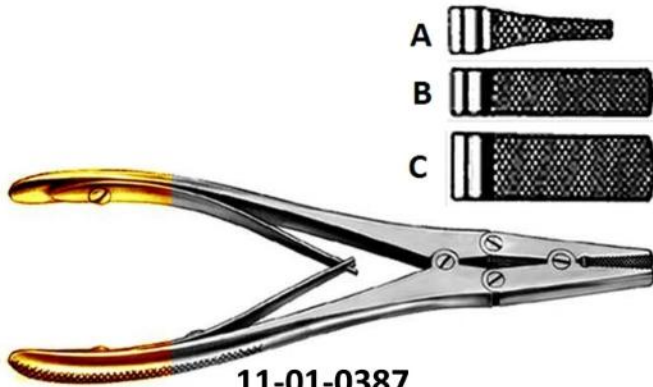

11-01-0387
Flat Nose Pliers 18 cm / 7" Parallel Grip



11-01-0388
Flat Nose Pliers 17 cm / 6 ¾" with crosswise groove



11-01-0389
Flat Nose Pliers 17.5 cm / 7"



11-01-0390
Flat Nose Pliers Pointed 19.5 cm / 7 ¾"



11-01-0391
Platypus Nail Pulling Forceps 15.5 cm / 6 ¼"

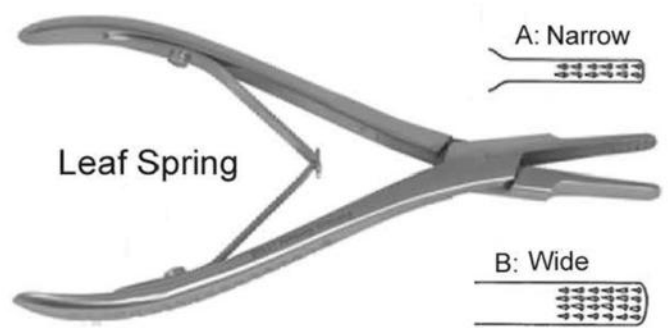

11-01-0392
Platypus Nail Pulling Forceps 15.5 cm / 6 ¼"



11-01-0393
Round Nose Pliers 15.5 cm / 6 ¼"

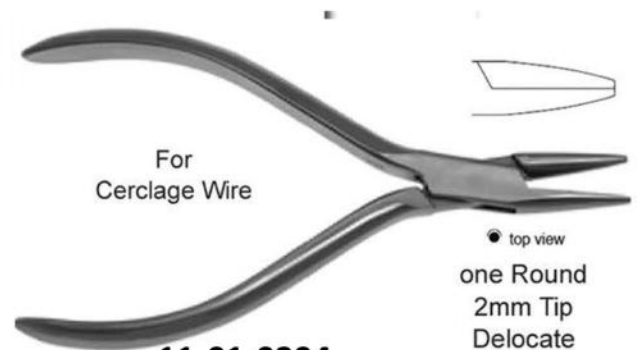

11-01-0394
Needle Nose Pliers 15.5 cm / 6 ¼"

NOSE PLIERS – PULLING FORCECEPS – WIRE CUTTERS

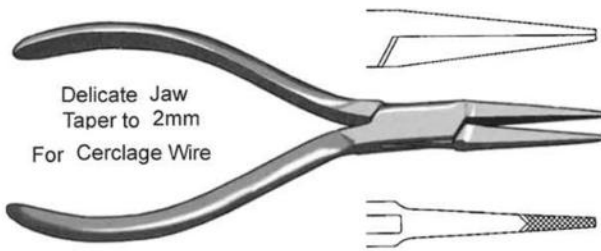

11-01-0395
Flat Nose Pliers 15 cm / 6"

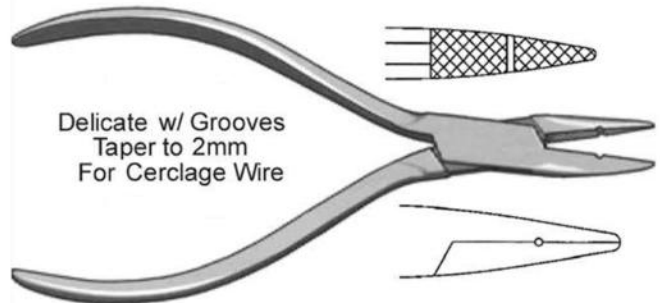

11-01-0396
Needle Nose Pliers 13.5 cm / 5 1/4"

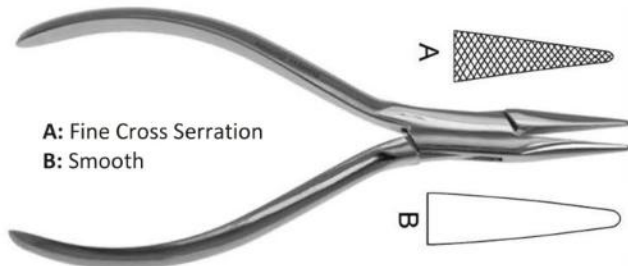

11-01-0397
Needle Nose Pliers Taper to 2mm Tip 14 cm / 5 1/2"

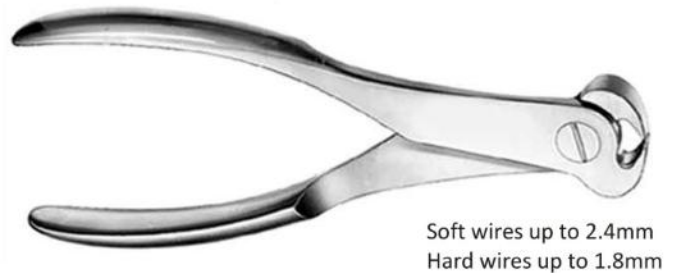

11-01-0398
Wire Cutting Pliers 18.5 cm / 7 1/4"



11-01-0399
Martin "Diamant" 16cm / 6 1/4"



11-01-0400
Circlage Pliers / Cutter 14 cm / 5 1/2"

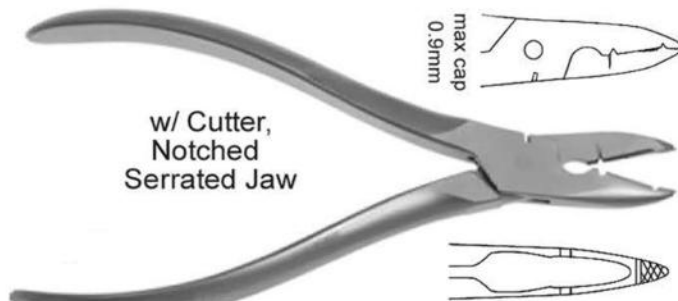

11-01-0401
Wire Bending Pliers 20 cm / 8"

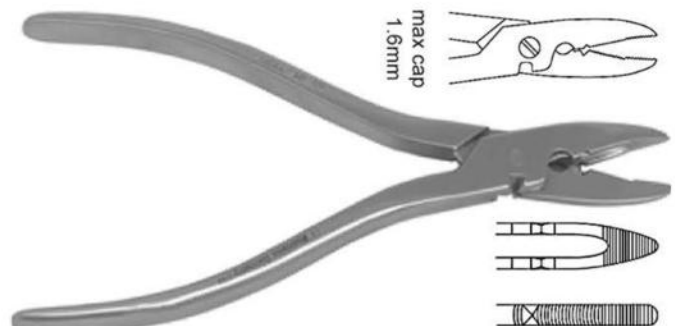

11-01-0402
Wire Bending Pliers 15 cm / 6"

NOSE PLIERS – PULLING FORCECEPS – WIRE CUTTERS



11-01-0403
Wire Bending Pliers TC 20 cm / 8"

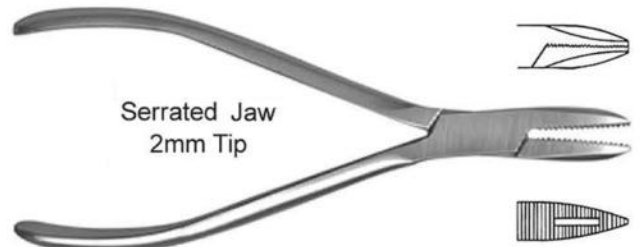

11-01-0404
Needle Nose Pliers 15 cm / 6"

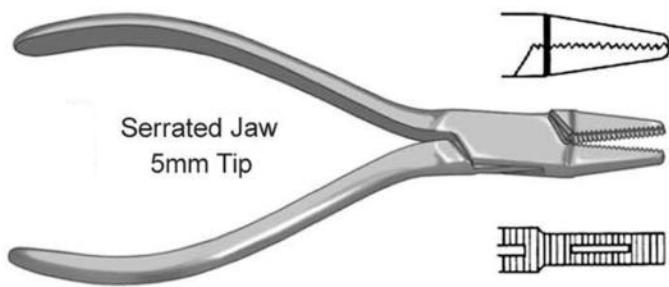

11-01-0405
Flat Nose Pliers 14 cm / 5 1/2"

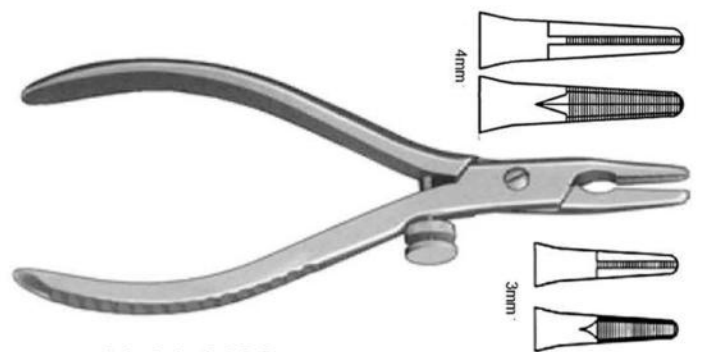

11-01-0406
K-Wire Pliers A: 13 cm / 5" B: 17.5 cm / 7"



11-01-0407
Screw/Pin Removing Pliers 19 cm / 7 1/2"

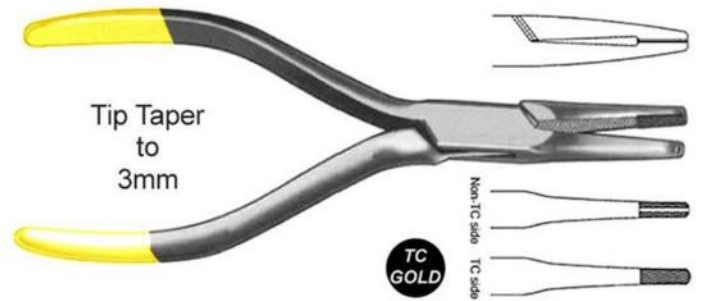

11-01-0408
Pin Puller Grips Small Pins 14 cm / 5 1/2"

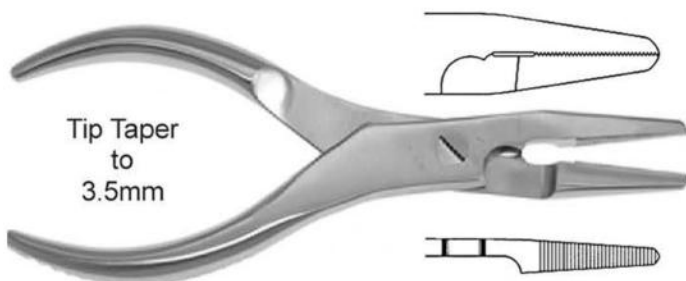

11-01-0409
Flat Nose Pliers w/ Cutter for Cerclage Wire 16 cm / 6 1/2"



11-01-0410
19 cm / 7 1/2" Narrow Nose Pliers Heavy Jaws for Pulling Wire / Pins

PLIERS – BENDERS – ROD INSTRUMENTS

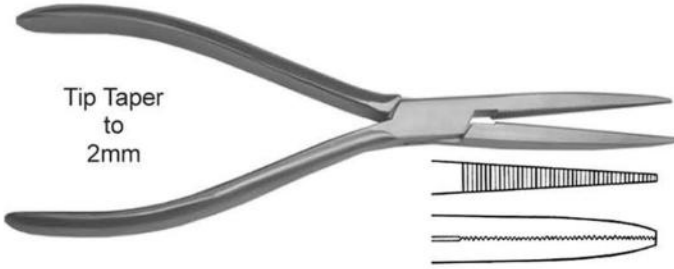

Tip Taper to 2mm

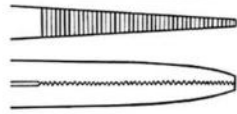

11-01-0411

Long Jaw Pliers 2inch Long Jaw Delicate 17.5 cm / 7"

- A: 17.5 cm / 7" Needle Nose 2" Jaw
- B: 16 cm / 6 1/2" Square 7mm Jaw
- C: 18 cm / 7" Tape to 2mm Tip

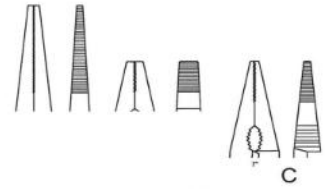

11-01-0412

UNIVERSAL Pliers
Serrated w/ Heavy duty Spring and Cutting Edge
Max Cutting Cap: 1.1 mm

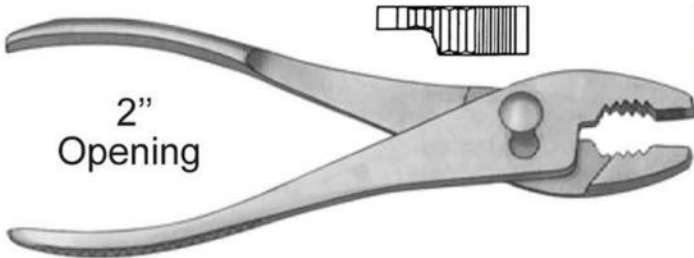

2" Opening



11-01-0413

Slip Joint Pliers 20 cm / 8"

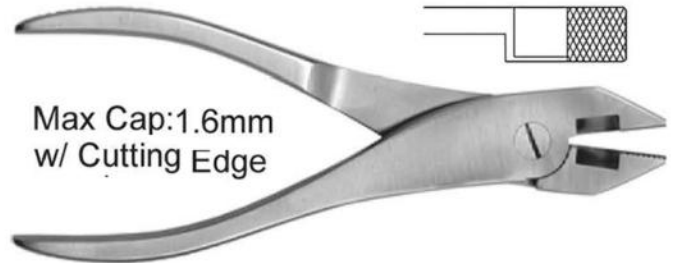

Max Cap: 1.6mm w/ Cutting Edge

11-01-0414

Lineman Pliers 21 cm / 8 1/2"

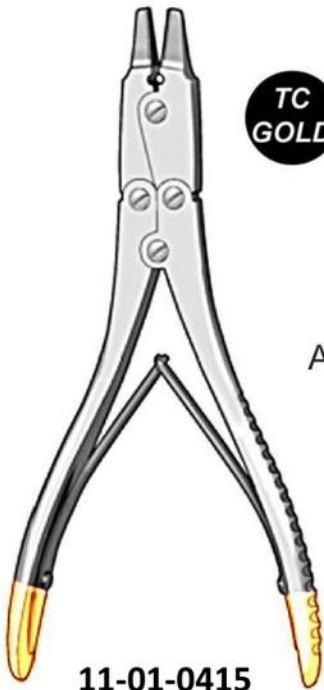

TC GOLD

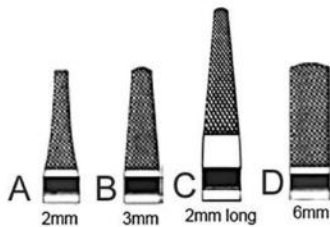

- A: 2mm Delicate Jaw TC
- B: 3mm Jaw TC
- C: 2mm Long Jaw TC
- D: 6mm Jaw TC

11-01-0415

Double Action Wire Extraction Plier
18 cm / 7"



11-01-0416

Gratloch Wire Bender
19 cm / 7 1/2"



Max Cap: 1.6mm

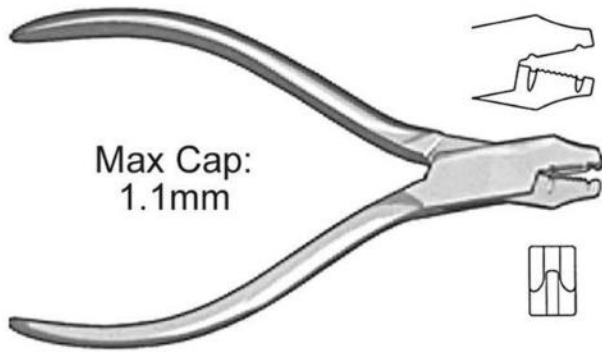

11-01-0417

K-Wire / Plate Bender 13.5cm / 5"

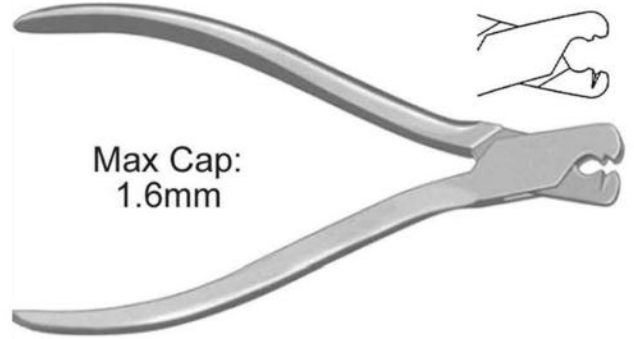

11-01-0418

K-Wire / Plate Bender 14.5 cm / 5 1/2"

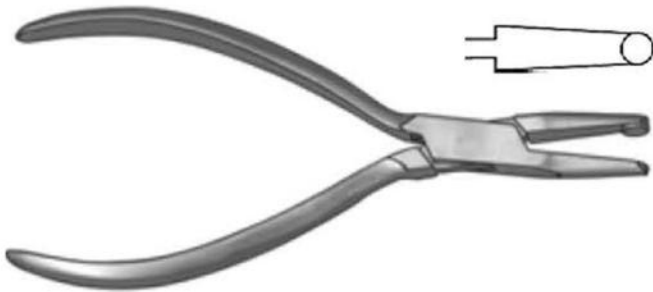

11-01-0419

Mini Plate Bending Pliers 13.5 cm / 5"

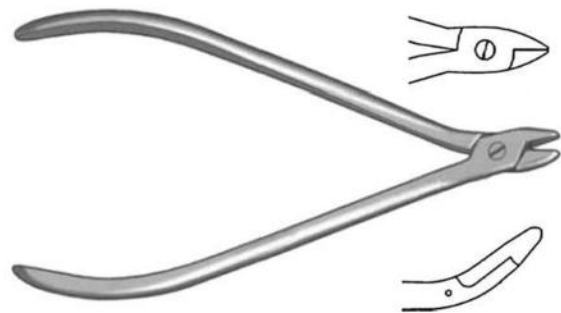

11-01-0420

Plate Bending Pliers 14.5 cm / 5 1/2"

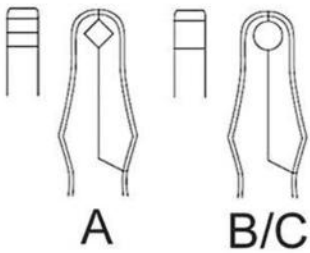

- A: 5.5mm Rods Prism
- B: 5.5mm Rods
- C: 6.35mm Rods

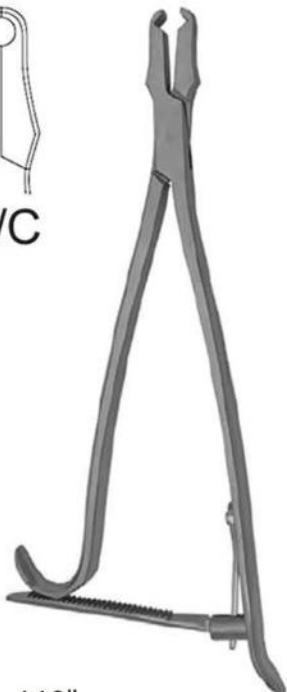

11-01-0421

Rod Holder STR 25 cm / 10"

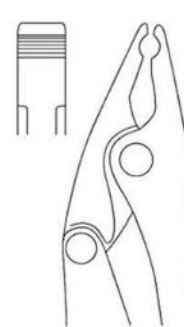

11-01-0422

Rod Gripper Adjustable
21 cm / 8 1/2"

WIRE INSTRUMENTS – EXTENSION BOWS

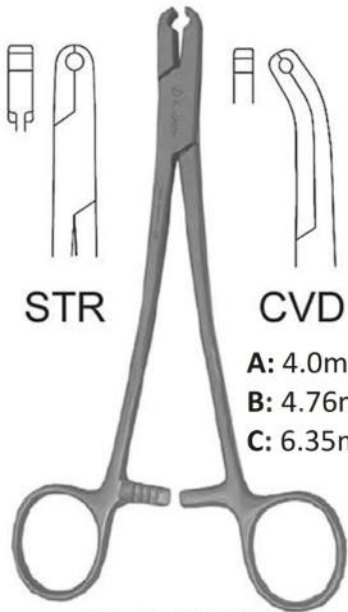

STR

CVD

- A: 4.0mm Rod
- B: 4.76mm Rod
- C: 6.35mm Rod

11-01-0423

Rod Holder 18 cm / 7 ¼"



11-01-0424

Wire Pulling Forceps 16 cm / 6 ½"

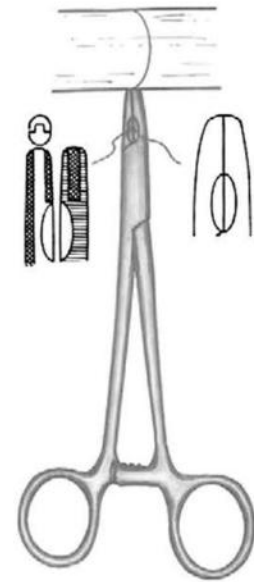

11-01-0425

Wire Twister / Tightner 16cm / 6 ¼"



11-01-0426

Loute Wire Tightener 21 cm / 8 ¼"



11-01-0428

Wire Tightener w / T Handle
11.5 cm / 4 ½"



11-01-0427

Wire Tightener 12 cm / 4 ¾"

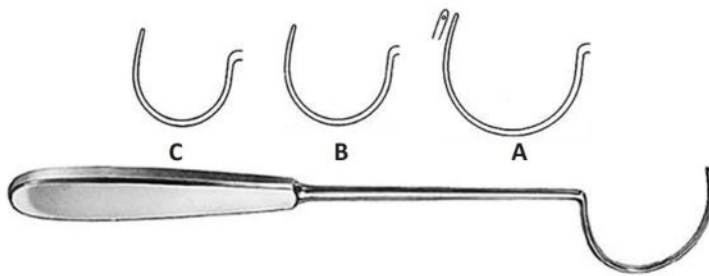

A: 31 cm / 12 1/4"
 B: 29 cm / 11 1/2"
 C: 28 cm / 11"

11-01-0429
 Demel Wire Guide

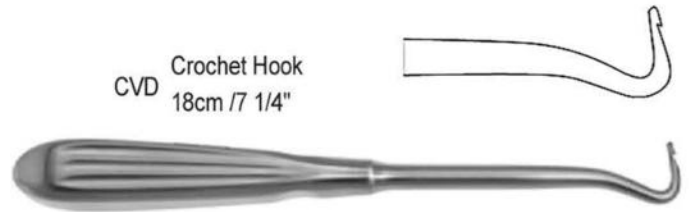

CVD Crochet Hook
 18cm / 7 1/4"

11-01-0430
 Bankert Ligature Carrier

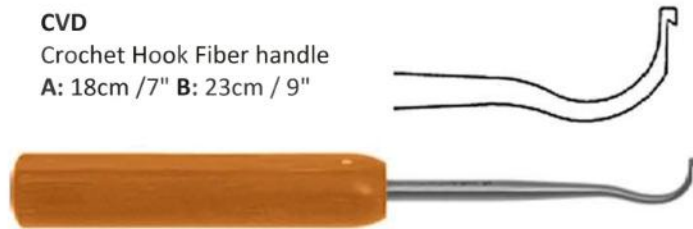

CVD
 Crochet Hook Fiber handle
 A: 18cm / 7" B: 23cm / 9"

11-01-0431
 Suture Passer

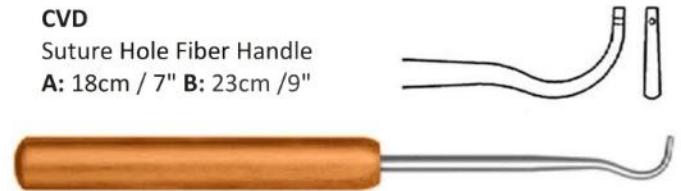

CVD
 Suture Hole Fiber Handle
 A: 18cm / 7" B: 23cm / 9"

11-01-0432
 Suture Passer



Suture Hole
 20cm / 8"
 A: Right Blunt
 B: Left Blunt
 C: Right Sharp
 D: Left Sharp

11-01-0433
 Deschamps Ligature Carrier

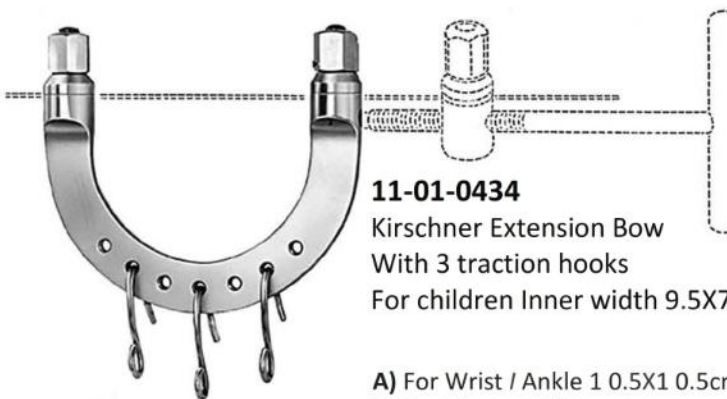

11-01-0434
 Kirschner Extension Bow
 With 3 traction hooks
 For children Inner width 9.5X7cm

- A) For Wrist / Ankle 1 0.5X1 0.5cm
- B) For Elbow 12X12cm
- C) For Knee 15.5X15.5cm
- D) For Femur 20X15.5cm

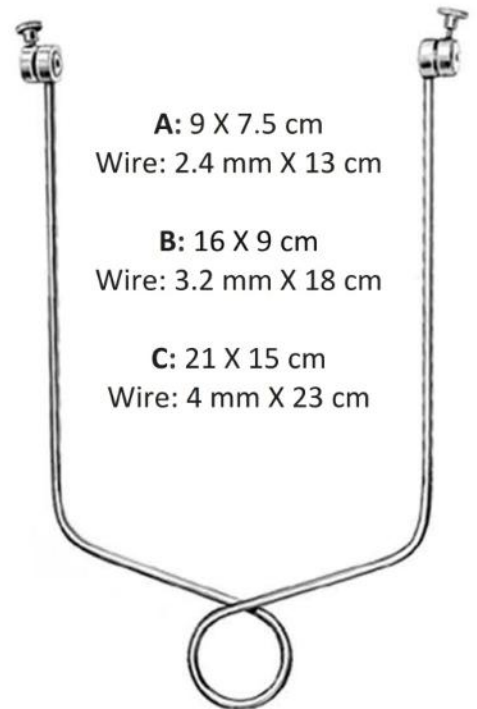

A: 9 X 7.5 cm
 Wire: 2.4 mm X 13 cm
 B: 16 X 9 cm
 Wire: 3.2 mm X 18 cm
 C: 21 X 15 cm
 Wire: 4 mm X 23 cm

11-01-0435
 Bohler Extension Bow for femur & knee

WIRE INSTRUMENTS – EXTENSION BOWS

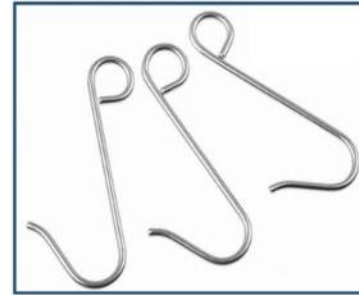
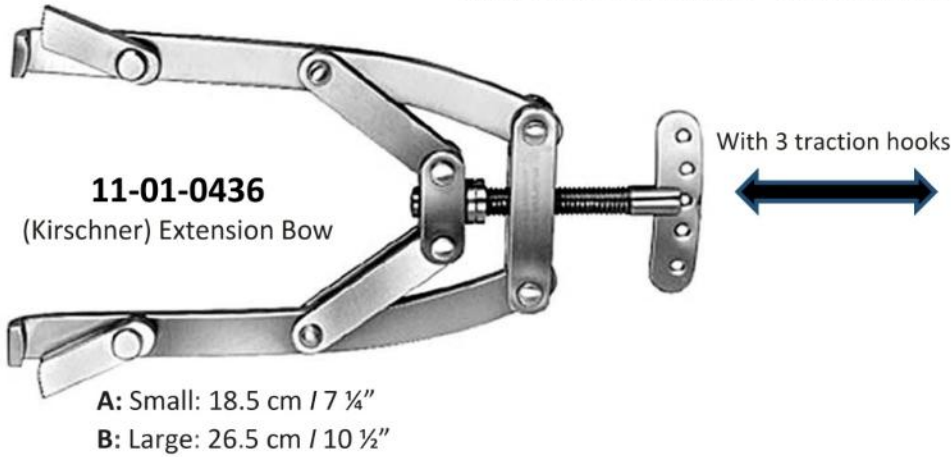

**Traction Hook
For Extension Bows**



11-01-0437
Extension Bow
A: 10 ½" X 6 ¼"
B: 7" X 4"



11-01-0438
Wire Strainer 18.5 cm / 7 ¼"



11-01-0439
Wrench 20 cm / 8"



11-01-0440
Fixation Discs
For wire drills, pair

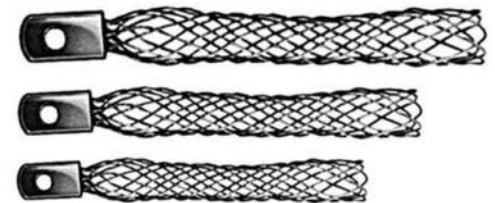

11-01-0441
Extension Sleeve
Small / Medium / Large

RING CUTTERS – LEAD HANDS – BIOPSY TOOLS

Complete with Drills
(Set of 3 drills) Small / Medium / Large

11-01-0442
Martin-Ideal
Finger Nail Drill

11-01-0443
Feldheim Tourniquet 10 cm / 4"

11-01-0444
Radolf Nail Extracting Forceps
14 cm / 5 1/2"

11-01-0445
Nail Extracting Forceps 16 cm / 6 1/4"

11-01-0446
Martin Finger Ring Saw 18.5 cm / 6 3/4"
Spare Blades are Available Separately

11-01-0447
Walton Finger Ring Saw 16cm / 6 1/4"
Spare Blades are Available Separately

11-01-0448
Finger Ring Saw 17cm / 6 3/4"
Spare Blades are Available Separately

Stainless Steel
Black Color

Stainless Steel
Color

11-01-0449
Finger Ring Saw Cutter Spare

RING CUTTERS – LEAD HANDS – BIOPSY TOOLS



11-01-0450

Lead Hand for Kids / Adults



11-01-0451

Lead Hand for Kids / Adults

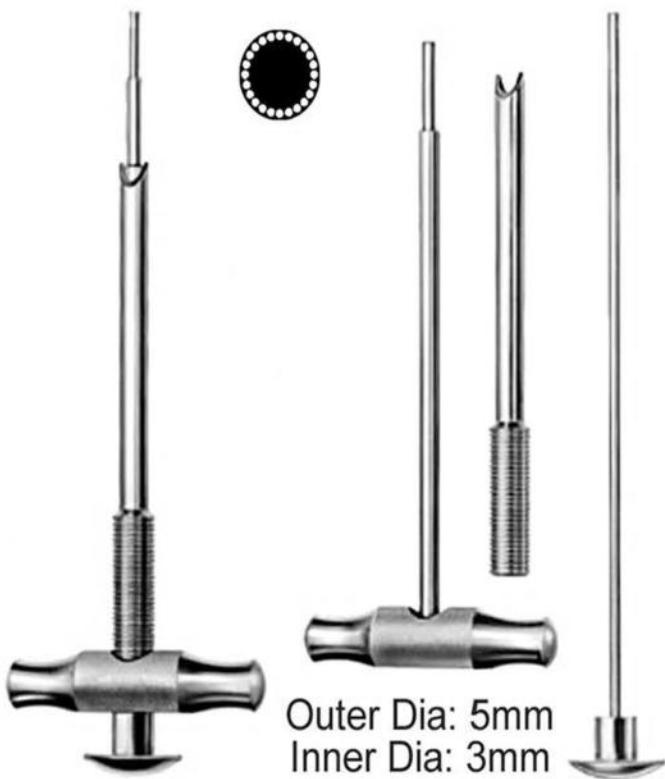

Outer Dia: 5mm
Inner Dia: 3mm

11-01-0452

Champy-OSU Bone Biopsy Instruments
22 cm / 8 3/4"

Consisting of trocar, a toothed trephine and a plunger for taking tibial and iliac bone grafts through a closed technique

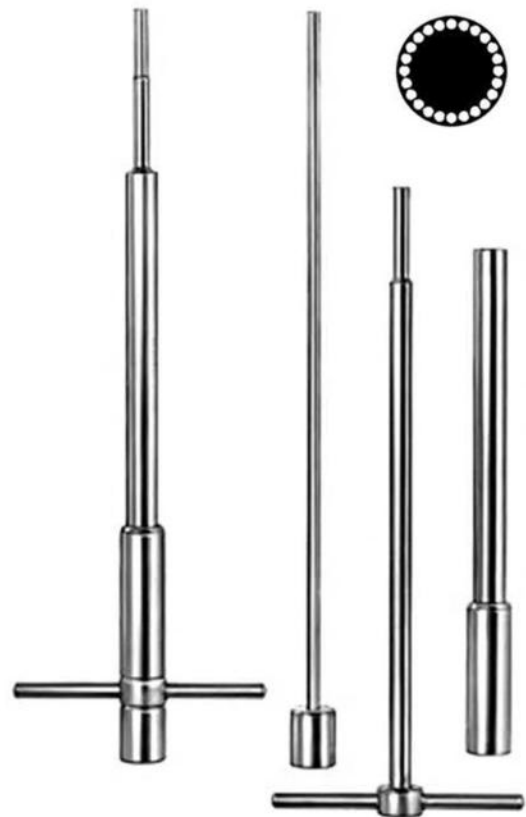

11-01-0453

Champy Bone Biopsy Instruments
22 cm / 8 3/4"

- A) Outer Dia: 5mm / Inner Dia: 4mm
- B) Outer Dia: 8mm / Inner Dia: 7mm

BONE TAMPERS – IMPACTORS - PACKERS



11-01-0454

Bone Tamper

15.5 cm / 6" Tip

Sizes: 2-3-4-5-6-8-9-10 mm



11-01-0455

Champy Cancellous Bone graft Mill

Outer Dia: 17mm

Inner Dia: 16mm

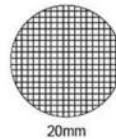

11-01-0456

Bone Impactor / Teflon Tip 17cm / 6 1/2"



11-01-0457

Caspar Bone Tamper 20 cm / 8"



11-01-0458

Lumbar / Cervical Impactor 21cm / 8 1/2"

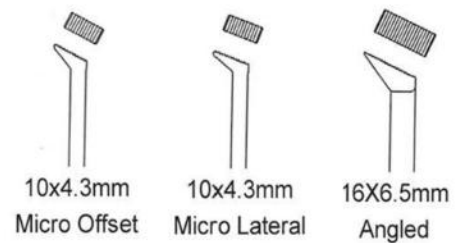

11-01-0459

Lumbar / Cervical Impactor 21cm / 8 1/2"

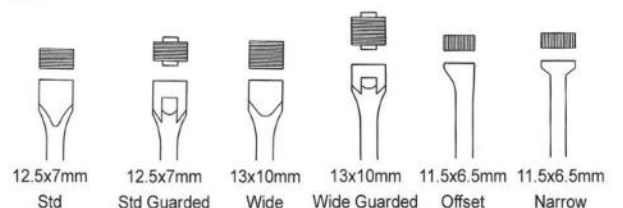

BONE RASPS - FILES



11-01-0460
Bone Chip Packer 25cm / 10"

A: 2x9mm B: 3x16mm
C: 6x9mm D: 6x19mm
E: 6mm Dia

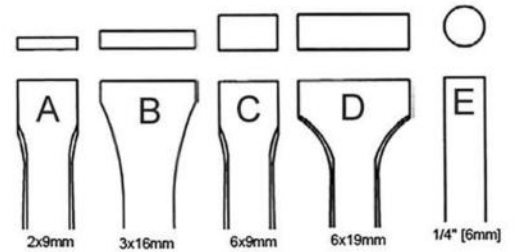

11-01-0461
Bone Tamper 43 cm / 17"



11-01-0462
Putti Bone Rasp Round / Semi Round
30 cm / 11 3/4"



11-01-0463
Putti Bone Rasp Curved / Straight
27cm / 10 3/4"



11-01-0464
Bone File 28 cm / 11" w/ Hollow Handle Semi Round



11-01-0465
Bone File 24.5 cm / 9 3/4" w/ Hollow Handle Semi



11-01-0466
Bone File 22 cm / 8 3/4" Flat / Round



11-01-0467
Bone Rasp 22 cm / 8 3/4" Flat / Round



11-01-0468
Bone File Fiber Handle 18cm / 7"

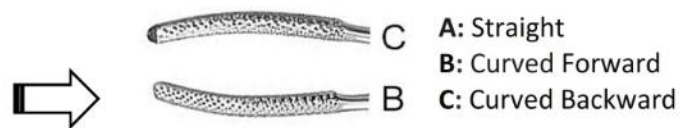

11-01-0469
Bone File 18 cm / 7" Fiber Handle / Cross-Hatch



11-01-0470
Bone File 18 cm / 7" Fiber Handle / Linear

BONE RASPS - FILES



11-01-0471A

Bone File 18 cm / 7" Fiber Handle / STR Diamond Coated



11-01-0471B

Bone File 18 cm / 7" Fiber Handle / CVD Diamond Coated



11-01-0472A

Bipolar Bone Rasp w / Rod



11-01-0472B

Femoral Bone Rasp w / Rod

A: Small B: Medium C: Large

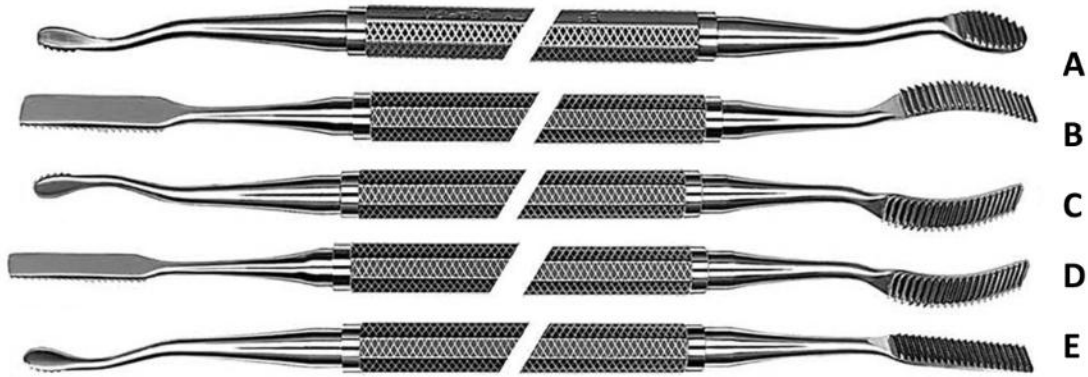

11-01-0473

Miller-Colburn Bone File 18 cm / 7" Downwards Cut

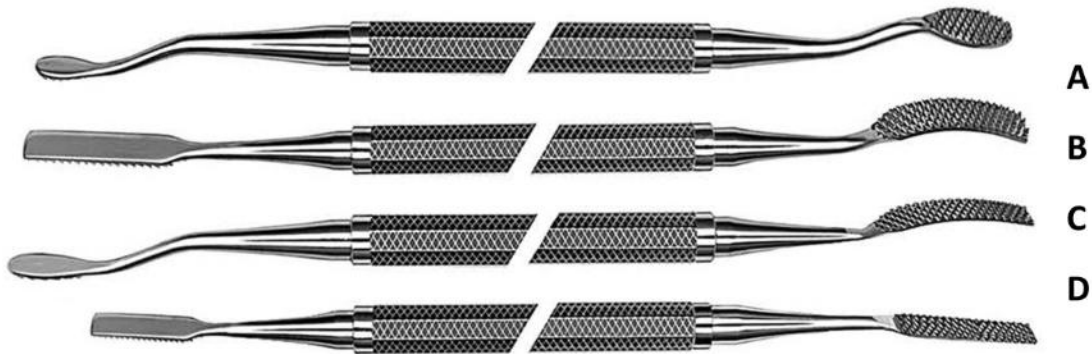

11-01-0474

Miller-Colburn Bone File 18 cm / 7" Cross Cut

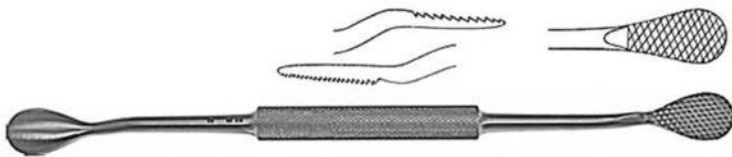

11-01-0475

Bone Rasp 21 cm / 8.5" 13mm Fine/Coarse Straight

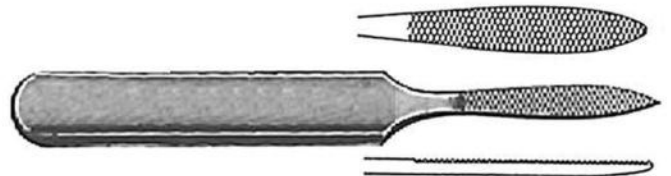

11-01-0476

Bone Rasp Joseph 16 cm / 6.25" 8mm Fine Cross Serrated / Straight

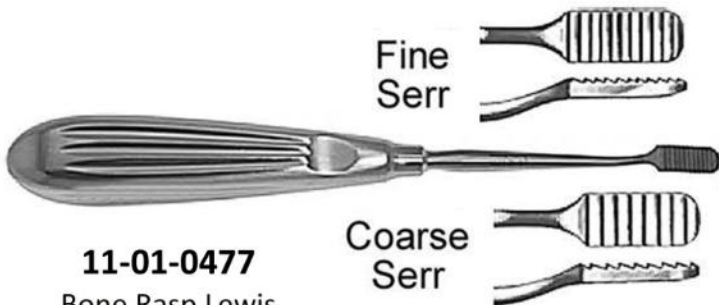

11-01-0477

Bone Rasp Lewis
19 cm / 7.5" 8mm

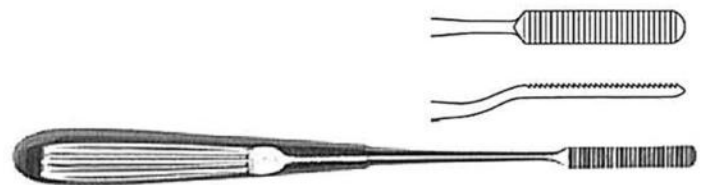

11-01-0478

Bone Rasp Cottle
20 cm / 8" 7mm Plain Serrated Downward

BONE RASPS - FILES

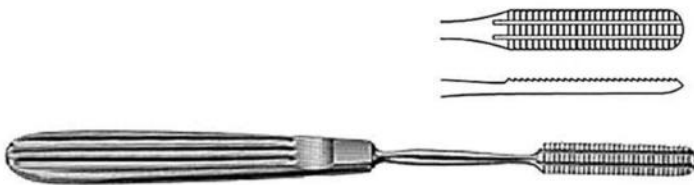

11-01-0479

Bone Rasp Maltz 18 cm / 7"
9mm Plain Coarse Serr Downward



11-01-0480

Bone Rasp Aufrieht 18 cm / 7"
9mm Coarse Serr CVD

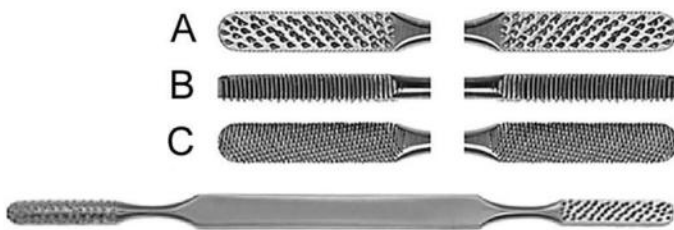

11-01-0481

Bone Rasp Fomon 21 cm / 8.5"
8mmX40mm Course Serr 4 Sided Flat / Convex Baldes



11-01-0482

Bone Rasp Fomon 21 cm / 8.5"
8mmX40mm Fine Serr 4 Sided Flat / Convex Blades

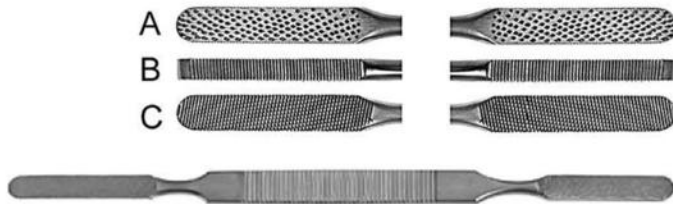

11-01-0483

Bone Rasp Kleinert Kurtz 21 cm / 8.5"
8mmX45mm Fine/Coarse Serr 4 Sided Flat / Convex



11-01-0484

Bone File / Rasp 21 cm / 8.5"
18mm Fine / Coarse Serr

BONE LEVERS - RETRACTORS



11-01-0485
Bone Lever 16 cm / 6 ¼"



11-01-0486
Hohman, Mini Bone Lever 16 cm / 6 ¼" 6 mm tip



11-01-0487
Hohman, Mini Bone Lever 16 cm / 6 ¼" 8 mm tip



11-01-0488
Mini Bone Lever 16cm / 6 ¼" 14 mm tip

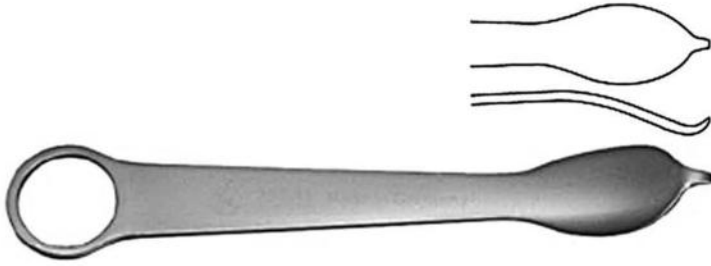

11-01-0489
Hohman, Mini Bone Lever 12 cm / 4 ¾" 14 mm tip

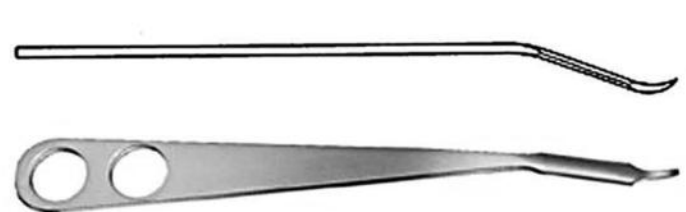

11-01-0490
Hohmann Bone Lever 22 cm / 8 ¾" 8 mm Tip narrow tip



11-01-0491
Hohmann Bone Lever 23.5 cm / 9 ¼" 18 mm Tip narrow tip



11-01-0492
Hohmann Bone Lever 23.5 cm / 9 ¼" 43 mm Tip narrow tip

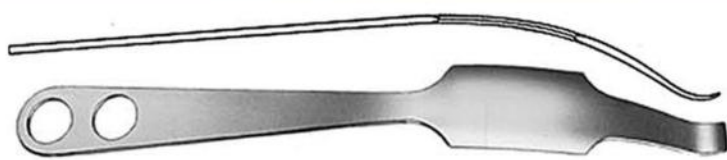

11-01-0493
Hohmann Bone Lever 29 cm / 11 ½" 35mm Tip wide tip



11-01-0494
Lange-Hohmann Bone Lever 25 cm / 9 ¾" 22mm Tip
Wide tip with groove

BONE LEVERS - RETRACTORS

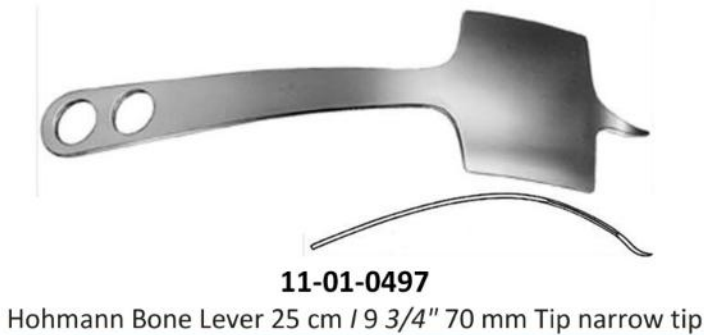
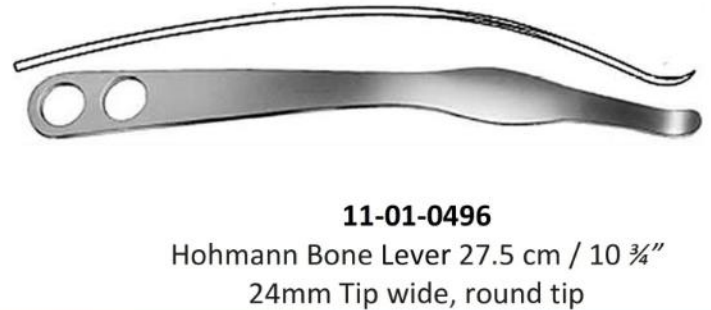
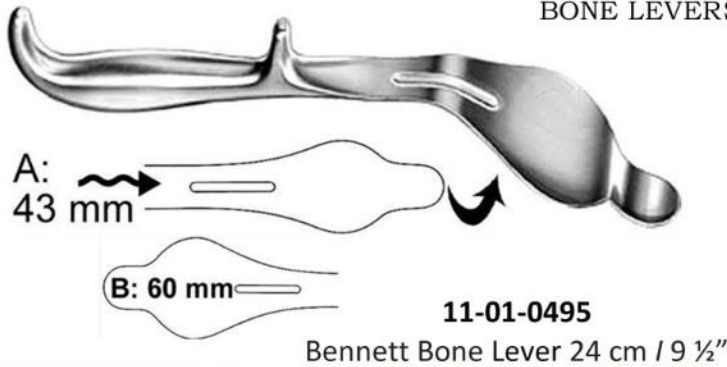

Sizes Available:

- A: 75 X 30 mm
- B: 100 X 30 mm

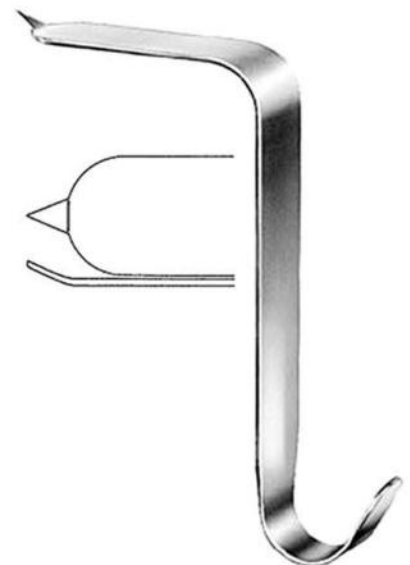

BONE LEVERS - RETRACTORS

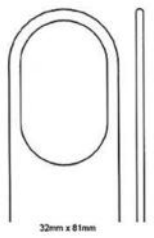

11-01-0504
Fukuda Retractor
19 cm / 7 1/2"
T-Handle

A: 32X81mm
B: 38X81mm

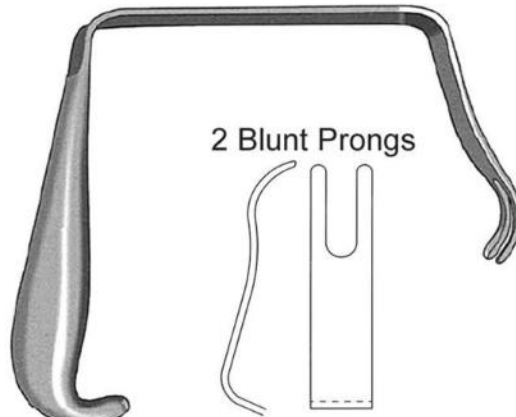

11-01-0505
Bristow / Bankart Humeral Retractor
18 cm / 7"



Medium Blade:
57 / 69mm Deep
11mm Wide

Large Blade:
63 / 76mm Deep
11mm Wide

11-01-0506
Z Knee Retractor 15 cm / 6"



11-01-0507
Deltoid Retractor 28 cm / 11" T Handle w / Ring



11-01-0508
Humeral Head Retractor 18 cm / 7" Strong Curved

22 mm Blade
1 Sharp Prong

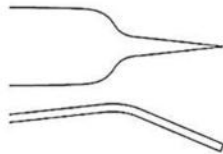

11-01-0509
Capsule Retractor 25 cm / 10"

22 mm Blade
2 Sharp Prong

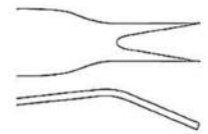

11-01-0510
Capsule Retractor 25 cm / 10"

3 Sharp Prongs

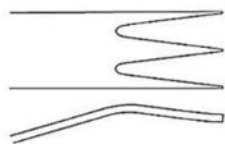

11-01-0511
Capsule Retractor 25 cm / 10"

Soft Tissue Retractor
3 Blunt Prong

22mm
Blade

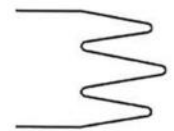

11-01-0512
Bristow / Bankart 19 cm / 7 1/2"

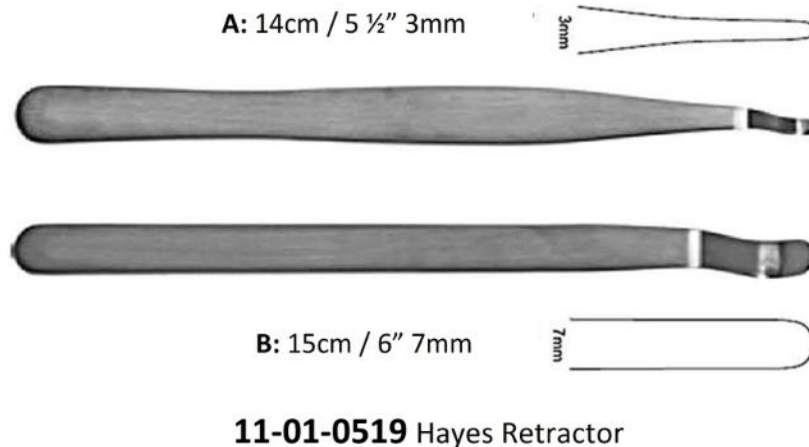
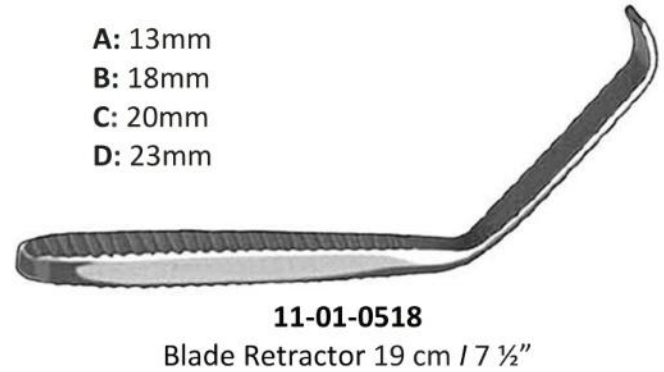
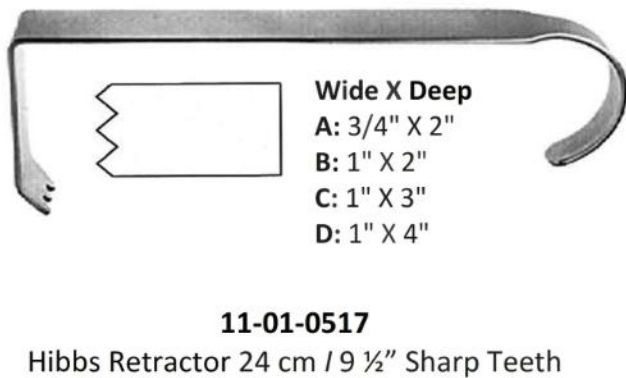
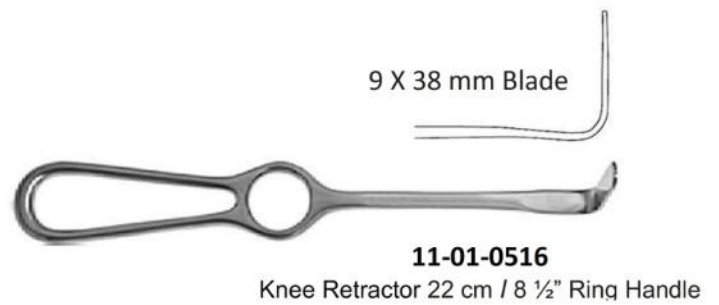
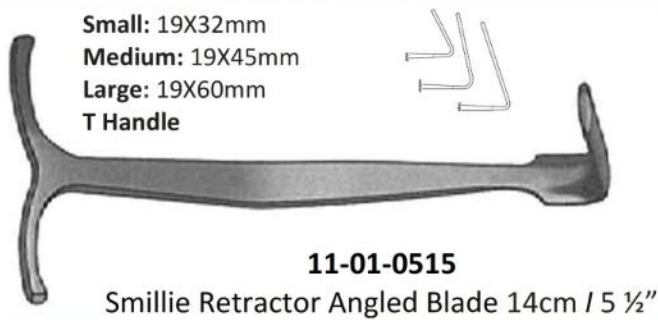
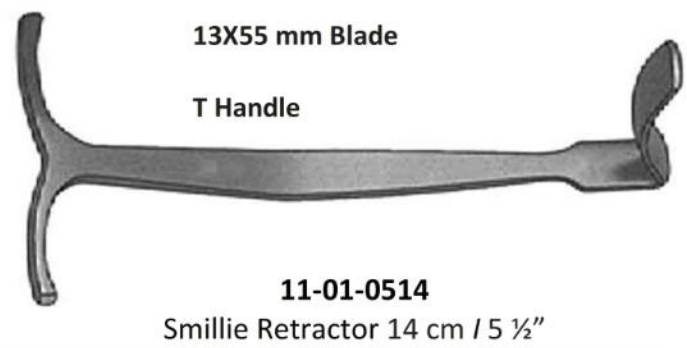
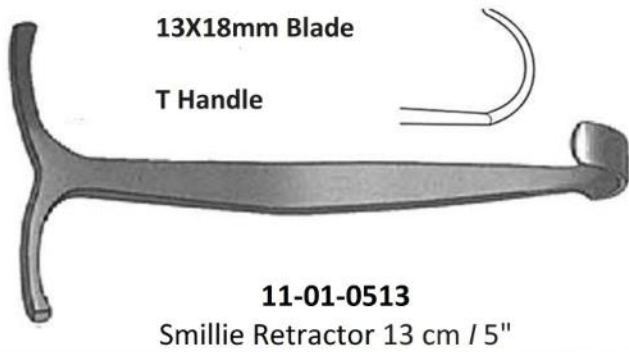

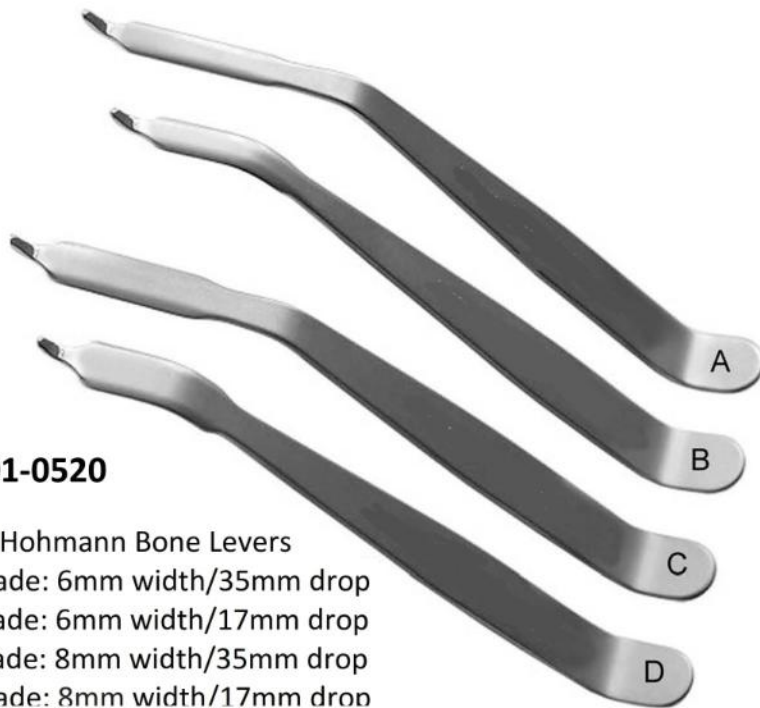

11-01-0520

Mini Hohmann Bone Levers

- A: Blade: 6mm width/35mm drop
- B: Blade: 6mm width/17mm drop
- C: Blade: 8mm width/35mm drop
- D: Blade: 8mm width/17mm drop

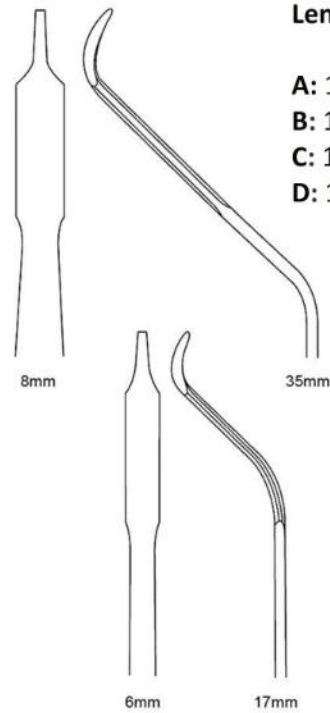

Length:

- A: 15cm / 6"
- B: 15.5cm/6 ¼"
- C: 15cm/6"
- D: 15.5cm/6 ¼"

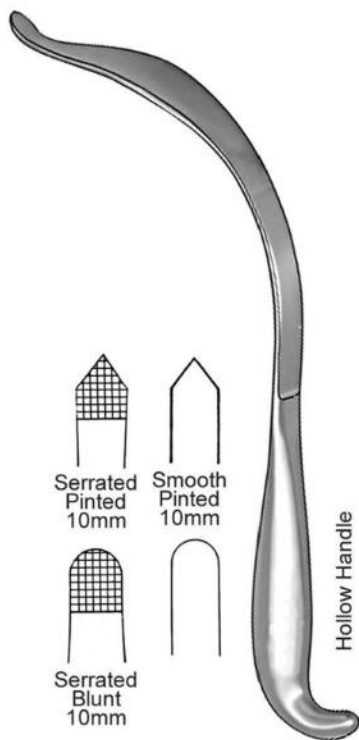

11-01-0521

Aufranc Cobra Retractor
26 cm / 10 ½"



11-01-0522

Aufranc Cobra Retractor
27.5cm / 11"

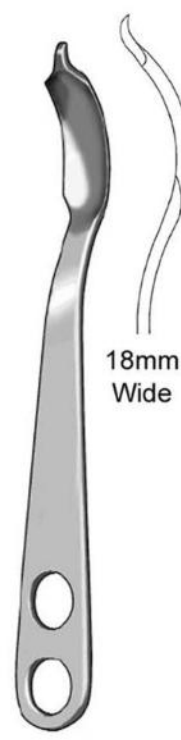

11-01-0523

Humeral Head Retractor
23 cm / 9"

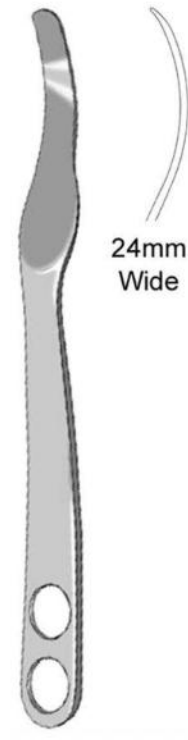

11-01-0524

Pelvic Retractor Single Prong
26 cm / 10 ½"

BONE LEVERS - RETRACTORS



11-01-0525

Ribbon Retractor Malleable
30 cm / 12"

AVAILABLE SIZES:

- | | | |
|-------------------------|----------------------|----------------------|
| A: 6" X 6mm | G: 8" X 10mm | M: 13" X 38mm |
| B: 6" X 12mm | H: 8" X 12mm | N: 13" X 45mm |
| C: 6" X 16mm | I: 8" X 16mm | O: 13" X 50mm |
| D: 6" X 19mm | J: 8" X 19mm | P: 13" X 65mm |
| E: 7 1/2" X 25mm | K: 13" X 19mm | Q: 13" X 75mm |
| F: 8" X 6mm | L: 13" X 30mm | |



11-01-0526

Murphy Bone Skid
30 cm / 12"

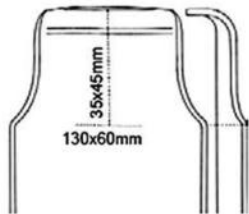

A: 29cm / 11 1/2" With Lip

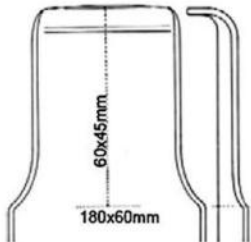

B: 33cm / 13" With Lip

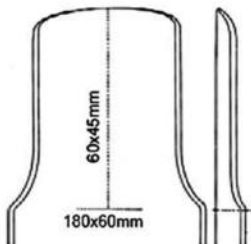

C: 33cm / 13" Without Lip



11-01-0527

St. Mark's Pelvic Retractor
Angled Blade

- A:** 22mm Blade
2 Finger Rings Long Round
- B:** 22mm Blade
1 Finger Ring Short Round

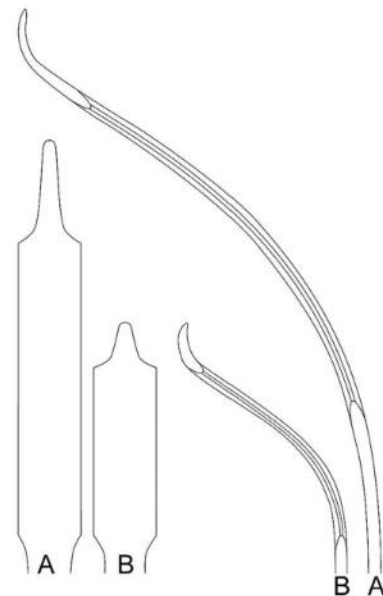
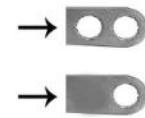

11-01-0528

Hohmann Retractor
40cm / 16"



BONE LEVERS - RETRACTORS

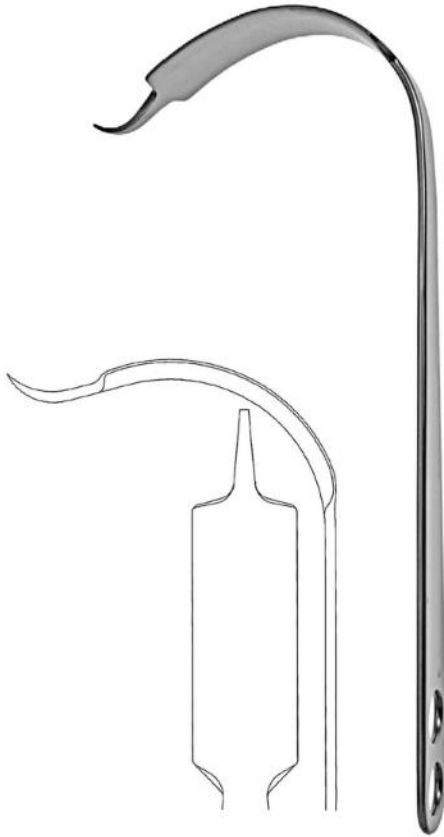

11-01-0529
Hohmann Retractor
33 cm / 13"



11-01-0530
Virchow Skull Breaker
7.5 cm / 3" 40 mm Blade Width

11-01-0531

Buckley Chisel
16cm / 6 1/4"
Octagonal handle

Fig A: 2mm
Fig B: 3mm
Fig C: 4mm



11-01-0532

Buckley Gouge
16cm / 6 1/4"
Octagonal handle

Fig A: 2mm
Fig B: 3mm
Fig C: 4mm

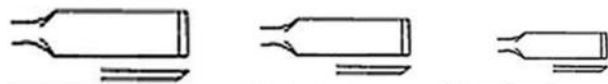

Fig C: 5mm Fig B: 4mm Fig A: 3mm



11-01-0533

Stout Bone Chisel 21 cm / 8 1/4" octagonal handle

11-01-0534

Bone Chisel 18 cm / 7" Round Handle

4mm



11-01-0535

Bone Chisel 17 cm / 6 3/4" Round Handle

4mm

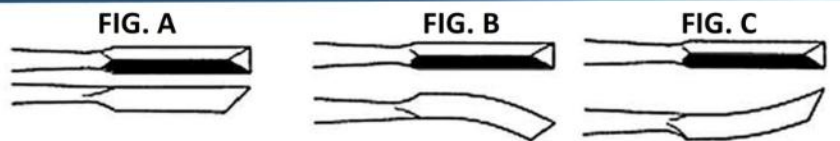

11-01-0536

Gardner Bone Chisel 17 cm / 6 3/4" 4 mm

CHISELS - OSTEOTOMES - GOUGES

FIG A: 3 mm

FIG B: 5 mm

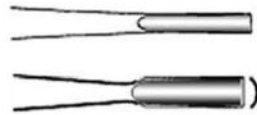

11-01-0537

Snyder-O.S.U Bone Chisel 16.5 cm / 6 1/2" 3 mm / 5 mm

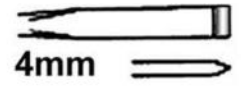

4mm



11-01-0538

Bone Chisel 18 cm / 7" Octagonal Handle 4 mm

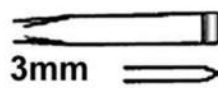

3mm



11-01-0539

Bone Chisel 18 cm / 7" Octagonal Handle 3 mm



FIG A



FIG B



11-01-0540

O.S.U. Bone Chisel 17 cm / 6 3/4" 7 mm / 9 mm

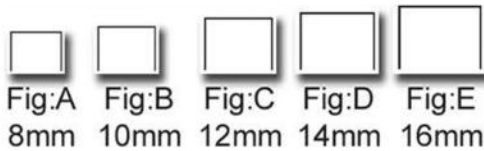
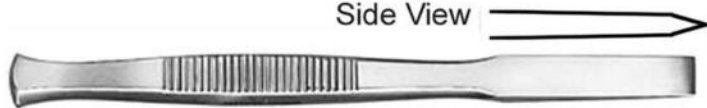

Fig:A 8mm Fig:B 10mm Fig:C 12mm Fig:D 14mm Fig:E 16mm

Side View



11-01-0541

Osteotome 13.5 cm / 5 1/4"

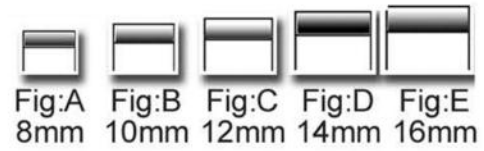
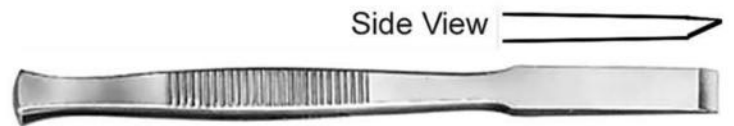

Fig:A 8mm Fig:B 10mm Fig:C 12mm Fig:D 14mm Fig:E 16mm

Side View



11-01-0542

Chisel 13.5 cm / 5 1/4"

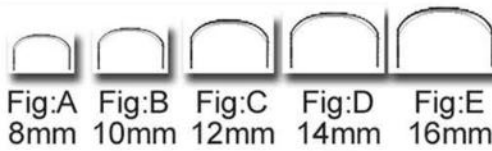
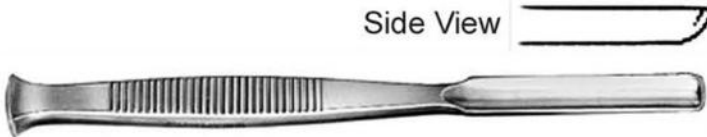

Fig:A 8mm Fig:B 10mm Fig:C 12mm Fig:D 14mm Fig:E 16mm

Side View



11-01-0543

Gouge 13.5 cm / 5 1/4"

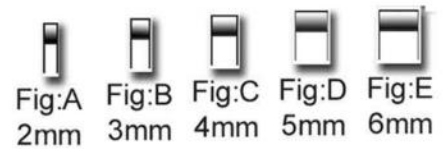

Fig:A 2mm Fig:B 3mm Fig:C 4mm Fig:D 5mm Fig:E 6mm

Side View



11-01-0544 Partsch Chisel 13.5 cm / 5 1/4"

11-01-0545 Partsch Chisel 17 cm / 6 3/4"

CHISELS - OSTEOTOMES - GOUGES

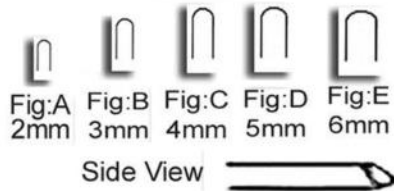

11-01-0546 Partsch Gouge 13.5 cm / 5 ¼"

11-01-0547 Partsch Gouge 13.5 cm / 5 ¼"

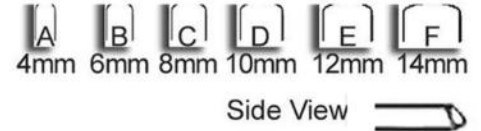

11-01-0548 Alexander Gouge 17.5 cm / 7"

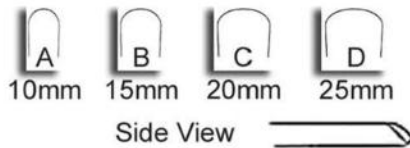

11-01-0549 Stille Gouge 20 cm / 8"

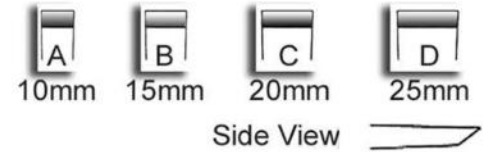

11-01-0550 Stille Chisel 20 cm / 8"

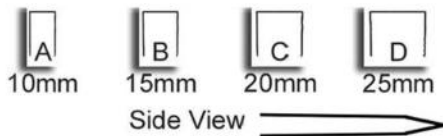

11-01-0551 Stille Osteotome 20 cm / 8"

11-01-555
Lambotte, Osteotome
24 cm / 9 ½"
Curved Tip



Available in
15mm
20mm
25mm
30mm
38mm
44mm
50mm

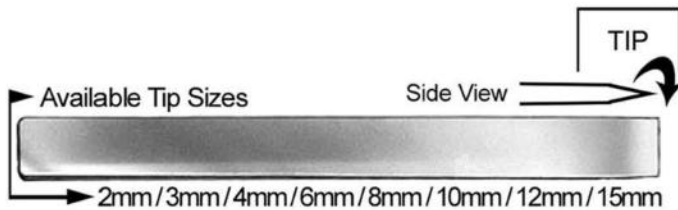

11-01-0552 (12.5 cm / 5") Lambotte, Mini Osteotome

11-01-0553 (17 cm / 6 ¾") Lambotte, Mini Osteotome
3mm / 4mm / 6mm / 8mm / 10mm / 12mm / 15mm

11-01-0554 (24 cm / 9 ½") Lambotte, Osteotome
15mm / 20mm / 25mm / 30mm / 38mm / 44mm / 50mm

CHISELS - OSTEOTOMES - GOUGES

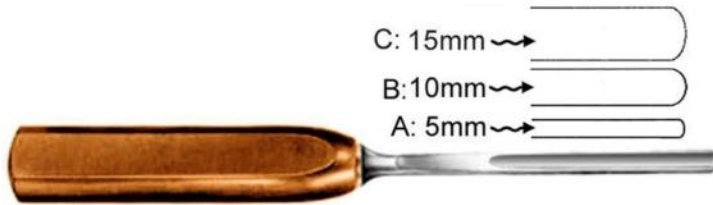

11-01-0556A

Lexer Spongiosa Gouge (25 cm / 9 3/4")

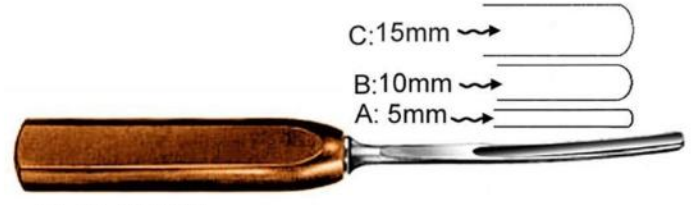

11-01-0556B

Lexer Spongiosa Gouge (25 cm / 9 3/4")

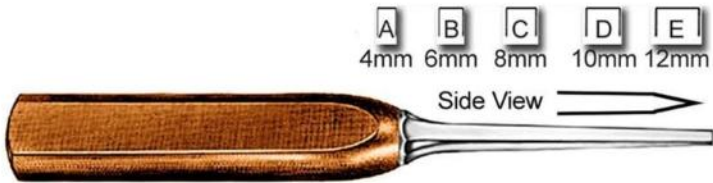

11-01-0557A

Lexer, Mini Osteotome 18.5 cm / 7 1/4"

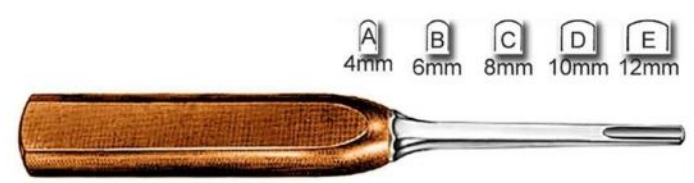

11-01-0557B

Lexer, Mini Osteotome 18.5 cm / 7 1/4"

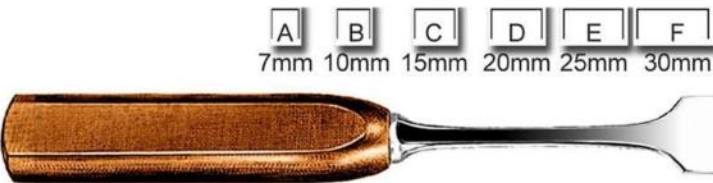

11-01-0558A

Lexer, Osteotome 22 cm / 8 3/4"

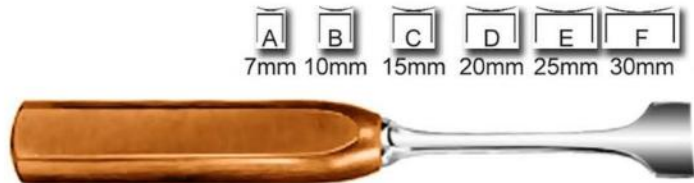

11-01-0558B

Lexer, Osteotome 22 cm / 8 3/4"



11-01-0559

Vickers Spongiosa Gouge 18 cm / 7"

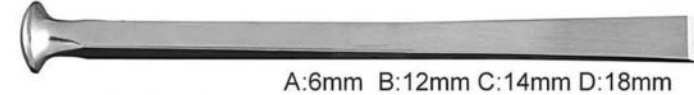

11-01-0560A

US Army Chisel 18 cm / 7"

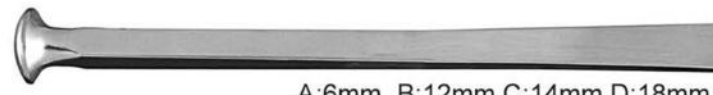

11-01-0560B

US Army Osteotome 18 cm / 7"



11-01-0560C

US Army Gouge 18 cm / 7"



11-01-0561A

Smith-Petersen Osteotome 20.5 cm / 8" Straight



11-01-0561B

Smith-Petersen Osteotome 20.5 cm / 8" Curved

CHISELS - OSTEOTOMES - GOUGES

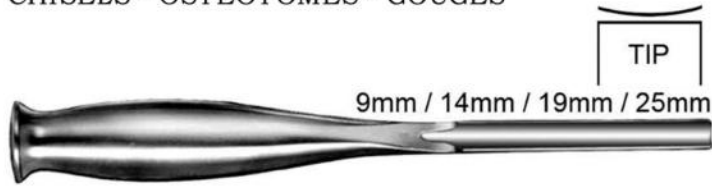

11-01-0561C

Smith-Petersen Gouge 20.5 cm / 8" Straight Tip

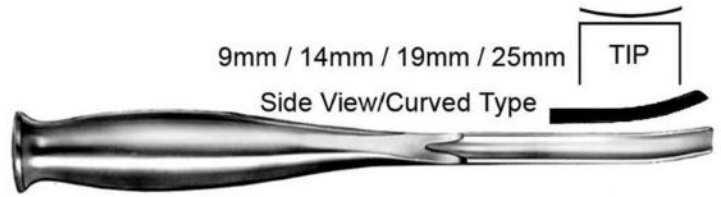

11-01-0561D

Smith-Petersen Gouge 20.5 cm / 8" Curved Tip



11-01-0562

Hook Osteotome 17 cm / 6 3/4"



11-01-0563A

Hibbs Osteotome 24.5 cm / 9 3/4"

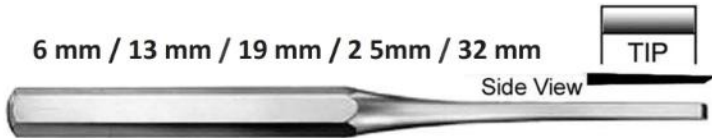

11-01-0563B

Hibbs Chisel 24.5 cm / 9 3/4"



11-01-0563C

Hibbs Gouge 24.5 cm / 9 3/4"

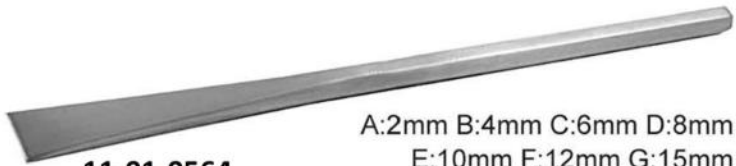

11-01-0564

Sheehan Osteotome 16cm / 6 1/2"



11-01-0565A

Silver Osteotome 18 cm / 7" Straight



11-01-0565B

Silver Osteotome 18 cm / 7" Curved Right



11-01-0565C

Silver Osteotome 18 cm / 7" Curved Left



11-01-0566

Shoulder Penetrating Gouge 21 cm / 8 1/2"

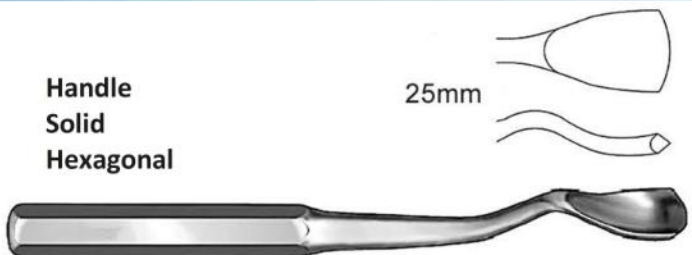

11-01-0567

Swan Neck Gouge 23 cm / 9"

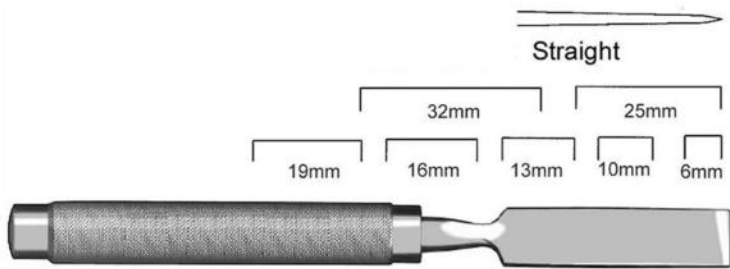

11-01-0568A

Cobb Osteotome 28 cm / 11" Straight

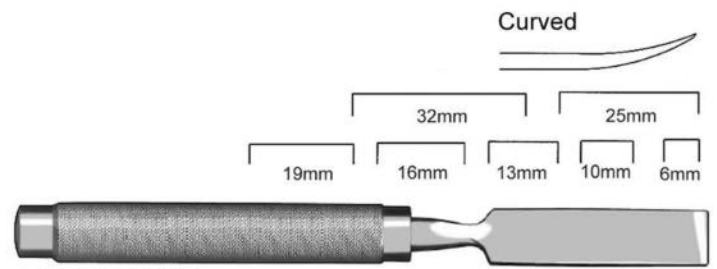

11-01-0568B

Cobb Osteotome 28 cm / 11" Curved

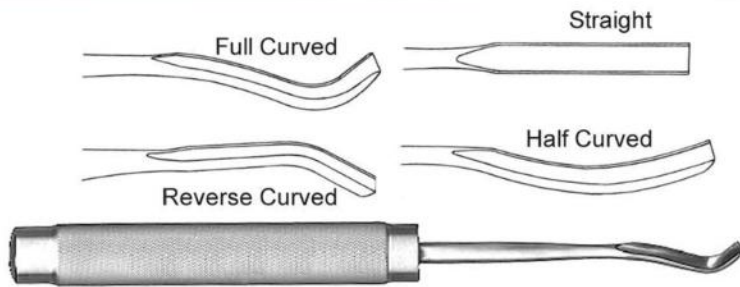

11-01-0569

Cobb Gouge 28 cm / 11"



11-01-0570

Lexer Osteotome Angled / 28 cm / 11"

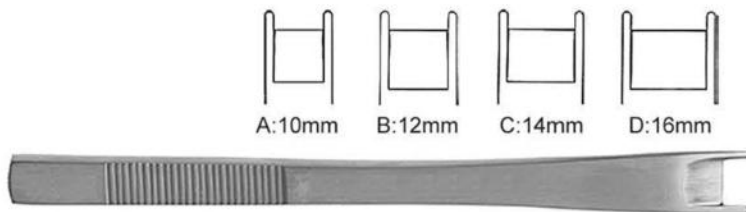

11-01-0571

Cinelli Osteotome 15.5 cm / 6 1/2"

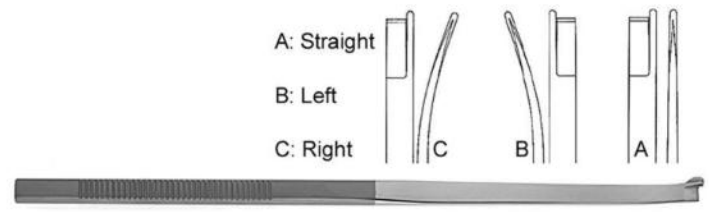

11-01-0572

Anderson Neivert Osteotome 20 cm / 8"

11-01-0573

Hibbs Osteotome 47 cm / 18 1/2" 10 mm Tip
3 1/2" Tip L / 10 3/4" Shaft L / 4 1/4" Handle L
11.5 mm Shaft Diameter

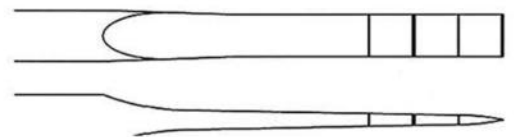

11-01-0574

Hibbs Gouge 47 cm / 18 1/2" 10 mm Tip
3 1/2" Tip L / 10 3/4" Shaft L / 4 1/4" Handle L
11.5 mm Shaft Diameter

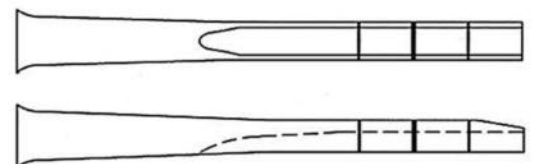

CHISELS - OSTEOTOMES - GOUGES



11-01-0575

Spinal Fusion Gouge 24 cm / 9 1/2" 6 mm Tip

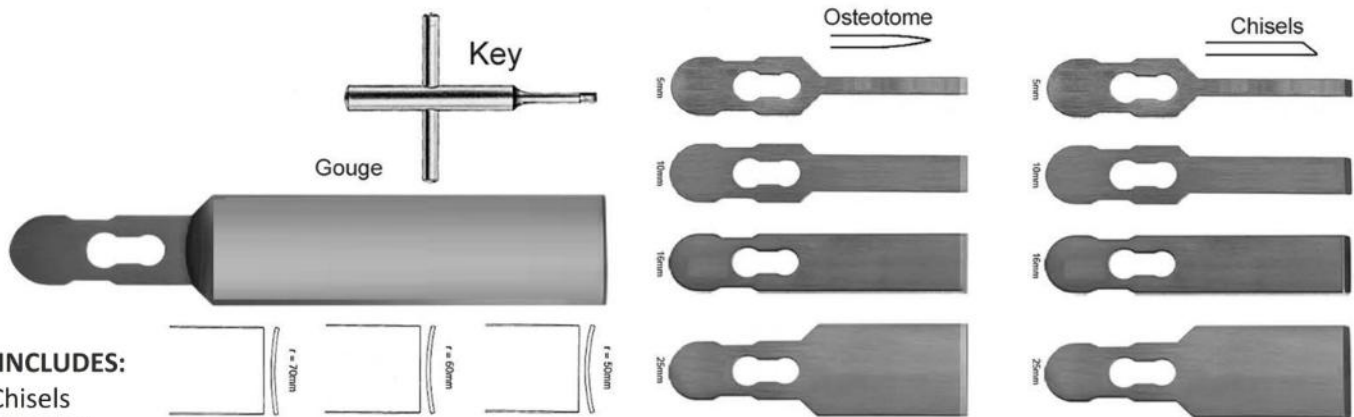

SET INCLUDES:

- 5 x Chisels
5/10/15/25mm
- 5 x Osteotomes
5/10/15/25mm
- 3 x Gouges
50/60/70mm Radius
- 1 x Handle Fibre
- 1 x Key

11-01-0576

Chisel Handle Fibre w/Chisel-Osteotome-Gouge Blades 18.5 cm / 7 1/4"



11-01-0577

Volkman Bone Curette 18.5 cm / 7 1/4" oval with plastic handle

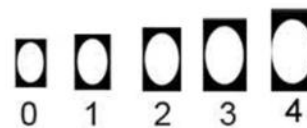

11-01-0578

Volkman Bone Curette 27.5 cm / 10 3/4" oval with plastic handle

BONE CURETTES

A: 13 cm / 5"
 B: 16 cm / 6 ¼"
 C: 20 cm / 8"

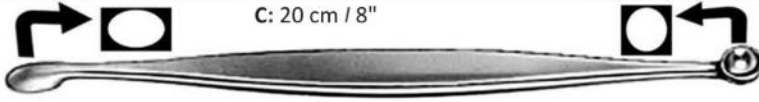

11-01-0579

Volkman Bone Curette, double-ended (oval / round)



11-01-0580

Bone Curette, double-ended (round / oval) 21 cm / 8 ¼"



11-01-0581

Schede Bone Curette 17 cm / 6 ¾" oval with hollow handle

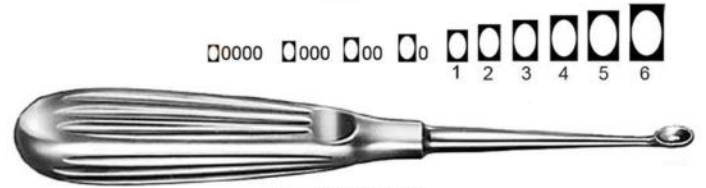

11-01-0582

Volkman Bone Curette 17 cm / 6 ¾" oval, with hollow handle

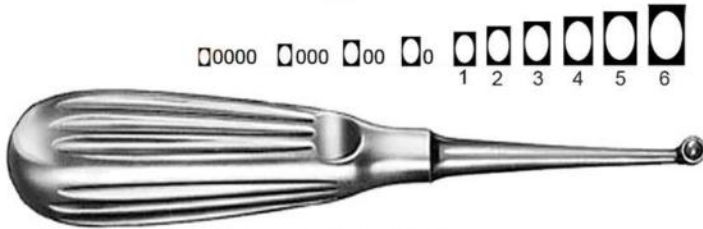

11-01-0583

Bruns Bone Curette 17 cm / 6 ¾" Round, with hollow handle

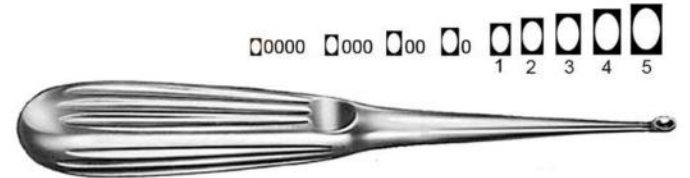

11-01-0584

Spratt Bone Curette 17 cm / 6 ¾" Oval, with hollow handle

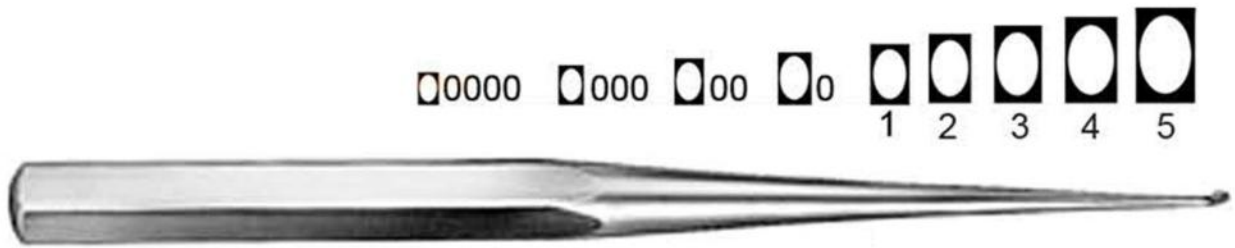

11-01-0585

Bruns Bone Curette 23 cm / 9" oval, solid



11-01-0586

Scoville Bone Curette 25 cm / 9 ¾" oval, with hollow handle



BONE CURETTES



11-01-0587

Simon Bone Curette 25 cm / 9 3/4" oval, with hollow handle



11-01-0588

Modell USA Bone Curette 16 cm / 6 1/4" Oval, with hollow handle



11-01-0589

Modell USA Bone Curette 15.5 cm / 6" Oval, with hollow handle



11-01-0590

Model USA Bone Curette 15.5 cm / 6" Oval, with hollow handle

BONE CURETTES



11-01-0591

Halle Bone Curette 21 cm / 8 1/4" oval, malleable shaft, with hollow handle

A: 00/0 ●/● B: 0/1 ●/● C: 1/2 ●/●

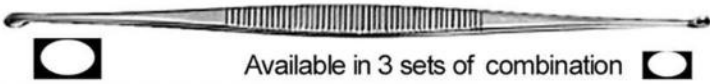

Available in 3 sets of combination

11-01-0592

Williger Bone Curette, double-ended 13.5 cm / 5 1/4" handle



A: 00/00 ●/● B: 0/0 ●/● C: 1/1 ●/●

11-01-0593

Williger Bone Curette, 17 cm / 6 3/4" double-ended oval / oval



A: 12.5 cm / 5"

B: 14.5 cm / 5 3/4"

C: 17 cm / 6 3/4"

11-01-0594

Volkman Bone Curette, double-ended

A: 1 R/L ●/● B: 2 R/L ●/● C: 3 R/L ●/●



11-01-0595

Hemingway-Martin Bone Curette, double-ended

18.5 cm / 7 1/4"



11-01-0596

Bone Curette, 17.5 cm / 7" double-ended round

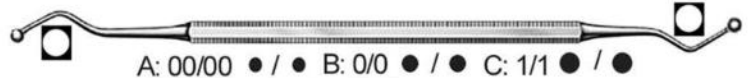

A: 00/00 ●/● B: 0/0 ●/● C: 1/1 ●/●

11-01-0597

Hemingway Bone Curette, double-ended, round / round

18.5 cm / 7 1/4" octagonal handle

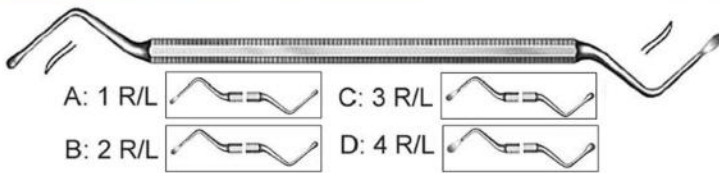

A: 1 R/L

B: 2 R/L

C: 3 R/L

D: 4 R/L

11-01-0598

Lucas Bone Curette, double-ended 18 cm / 7"

Octagonal handle

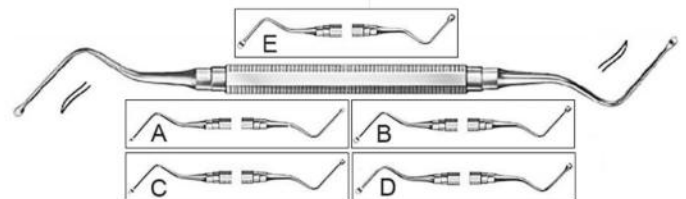

11-01-0599

Miller-Colburn Bone Curette, double-ended 17 cm / 6 3/4"

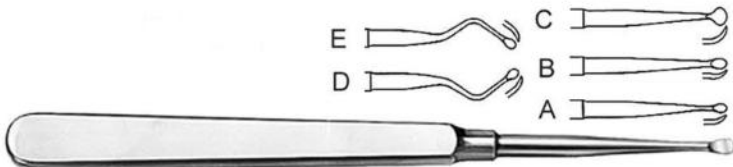

11-01-0600

Molt Bone Curette 17 cm / 6 3/4"

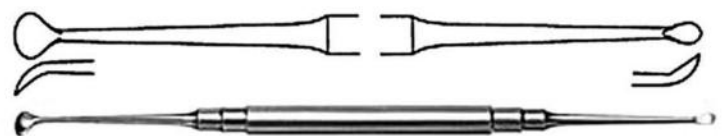

11-01-0601

Molt Bone Curette 19 cm / 7 1/2" Round Handle

BONE CURETTES

Hollow Handle
Oval Fenestrated
4X7mm Cup
Sharp/Blunt

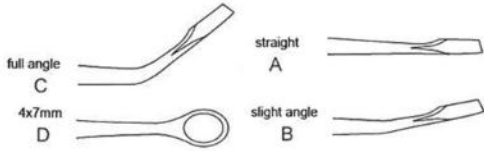

11-01-0602

Semmes Ring Curette 23 cm / 9"

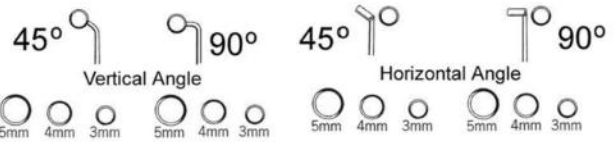

11-01-0603

Ray Pituitary Curette 18 cm / 7 1/2"

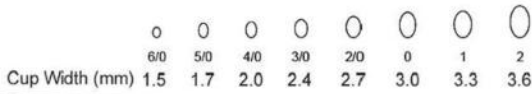

Hollow Handle

Str-Oval Cup

11-01-0604

Lempert Curette 18 cm / 7 1/2"

Reverse Up
Angle Oval Cup



Hollow Handle

11-01-0605

Epstein Curette 18 cm / 7 1/2"

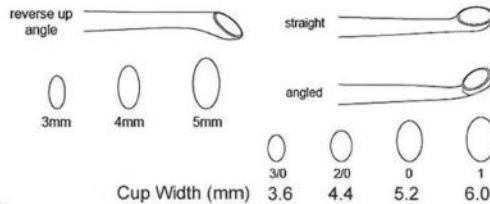

Hollow Handle

11-01-0606

Bushe Curette 25 cm / 10"

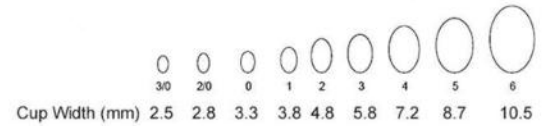

Solid Handle

Str-Oval Cup

11-01-0607

Spinal Fusion Curette 28 cm / 11"

Reverse Angle
4.7mm
Cup Width
90° Up



11-01-0608

Scoville Curette 25 cm / 10"

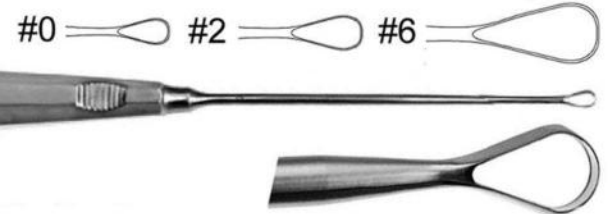

11-01-0609

Ring Curette

- A: 25 cm / 10" #0 6mm Cup
- B: 25 cm / 10" #2 8mm Cup
- C: 26 cm / 10 1/2" #6 14mm Cup
- D: 28 cm / 11 1/2" #0 6mm Cup
- E: 28 cm / 11 1/2" #2 8mm Cup
- F: 30 cm / 12 1/2" #6 14mm Cup

BONE CURETTES

Cup Size
2.8mm
3.3mm
3.6mm
4.3mm
4.8mm
5.6mm
6.0mm
6.7mm
8.8mm

Hollow Handle Solid Handle

11-01-0610
Cobb Curette Oval Cups
28 cm / 11"

Cup Size
2.8mm
3.3mm
3.6mm
4.3mm
4.8mm
5.6mm
6.0mm
6.7mm
8.8mm

Hollow Handle Solid Handle

11-01-0611
Cobb Curette Oval Cups
28 cm / 11"

straight	#4/0	cup width	
15°	#3/0	2.8mm	
15°	#0	3.6mm	
15°	#3	5.2mm	
15°	#0	10.0mm	
16°	#3/0	3.6mm	
16°	#2/0	4.4mm	
16°	#0	5.2mm	
angled	#4/0	2.8mm	
15°	#3/0	3.6mm	
15°	#0	5.2mm	
15°	#3	10.0mm	
16°	#3/0	3.6mm	
16°	#2/0	4.4mm	
16°	#0	5.2mm	
angled shaft	16 1/2°	#4/0	2.8mm
	16 1/2°	#3/0	3.6mm

11-01-0612
Sybert Curette Long
Delicate Shaft

Straight Angled Shaft

3mm
6mm
8mm

Knurled Aluminum Handle

11-01-0613
Cone Ring Curette
23 cm / 9"

- A: Straight 8mm Sharp/Blunt
- B: Straight 11 mm Sharp/Blunt
- C: Angled 8mm Sharp/Sharp
- D: Angled 11 mm Sharp/Sharp
- E: Angled 8mm Sharp/Sharp Right Cvd

- F: Angled 11 mm Sharp/Sharp Right Cvd
- G: Angled 8mm Sharp/Sharp Left Cvd
- H: Angled 11 mm Sharp/Sharp Left Cvd

11-01-0614
Zielke Ring Curette 34 cm / 13 1/2" TEFLON Handle

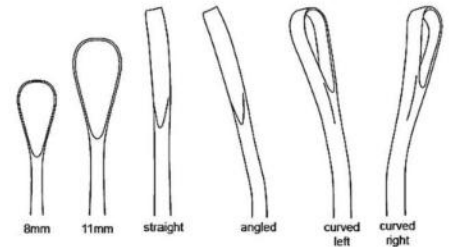

17" Angled 40° 3mm Diameter 2.7"
Tip Length Cone Ring Curette
Endoscopic Fibre Handle 9.3" Shaft
Length 5" Handle Length .285 (7
.2mm) Shaft Diameter

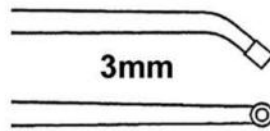

20" Angled 30°
6mm Diameter
3 1/2" Tip Length
10" Shaft Length
6 1/2" Handle Length
45" (11 .5mm)
Shaft Diameter

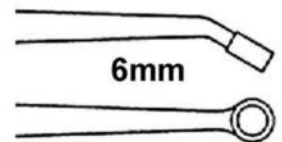

11-01-0615
Cone Ring Curette Endoscopic Fibre Handle

BONE CURETTES

17" Reverse Angled 40° 3mm x 6mm cup
2.7" Tip Length 9.3" Shaft Length 5" Handle
Length.285 (7.2mm) Shaft Diameter

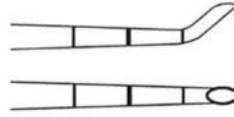

20" Reverse Angled 30°
6mm x 9mm cup 3 1/2"
Tip Length 10" Shaft
Length 6 1/2" Handle
Length .45 (7.2mm)
Shaft Diameter

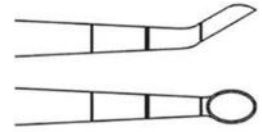

11-01-0616

Epstein Curette Endoscopic Fibre Handle

A: 17cm / 6 3/4" 8mm | B: 19cm / 7 1/2" 16 mm | E: 18.5cm / 7" 12 mm
C: 19cm / 7 1/2" 16 mm | D: 18.5cm / 7 1/4" 12 mm

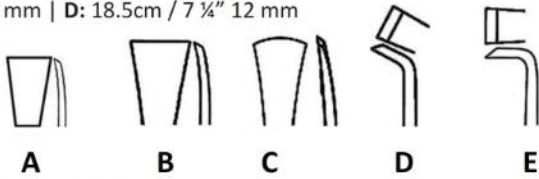

11-01-0617

Martin-Langenbeck Periosteal Elevator (Solid)

B: 18.5cm / 7 1/4" 15mm tip

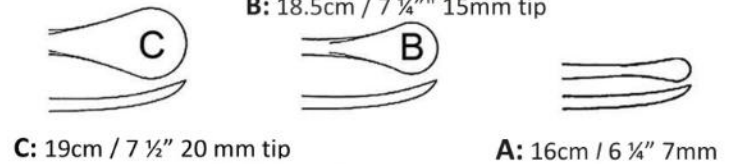

C: 19cm / 7 1/2" 20 mm tip

A: 16cm / 6 1/4" 7mm



11-01-0618

Martin-Langenbeck Periosteal Elevator (Solid)

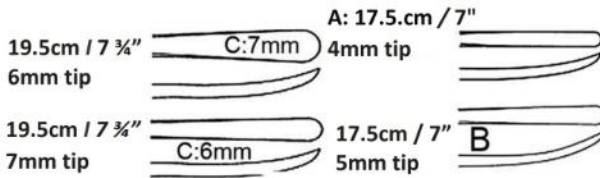

A: 17.5cm / 7"

19.5cm / 7 3/4"
6mm tip

C: 7mm

4mm tip

19.5cm / 7 3/4"
7mm tip

C: 6mm

17.5cm / 7"

5mm tip

B



11-01-0619

Martin-Langenbeck Periosteal Elevator (Solid)



11-01-0620

Langenbeck Periosteal Elevator 18.5 cm / 7 1/4"
With hollow handle



11-01-0621

Langenbeck Periosteal Elevator 19.5 cm / 7 3/4"
With hollow handle



Side View



11-01-0622

Periosteal Elevator 16 cm / 6 1/4" Delicate, solid

PERIOSTEAL ELEVATORS



11-01-0623

Farabeuf Periosteal Elevator 15 cm / 6"
With hollow handle



11-01-0624

Periosteal Elevator 3mm Tip 18 cm / 7"
Extra narrow, with plastic handle

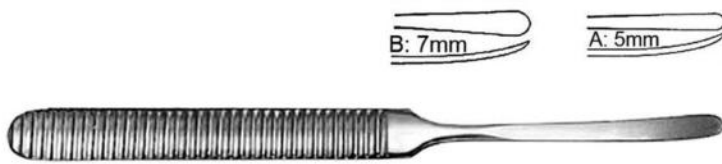

11-01-0625

Kahre-Williger 16 cm / 6 1/4"
Periosteal Elevator solid



11-01-0626

Kahre-Williger Periosteal Elevator solid
16cm / 6 1/4"



11-01-0627

Farabeuf Periosteal Elevator
15 cm / 6" with hollow handle



11-01-0628

Sedillot Periosteal Elevator 22 cm / 8 3/4" (15mm tip)



11-01-0629

Periosteal Elevator 20 cm / 8" (14 mm Tip)
With plastic handle



11-01-0630

Periosteal Elevator 19 cm / 7 1/2"
(14 mm Tip) with plastic handle



11-01-0631

Periosteal Elevator 6mm Tip
18 cm / 7" narrow, plastic handle



11-01-0632

Periosteal Elevator 18 cm / 7" narrow,
Plastic handle (6mm Tip)

PERIOSTEAL ELEVATORS - DISSECTORS



11-01-0633
Williger Periosteal Elevator
12.5 cm / 5" solid 5mm Tip



11-01-0634
Periosteal Elevator,
Double ended 17.5 cm / 7"

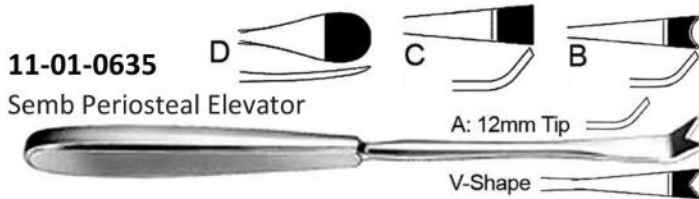

11-01-0635
Semb Periosteal Elevator
A: 12mm Tip
V-Shape
A+D: 21cm / 8 1/4" & B+C: 18.5 cm / 7 1/4"
A: V-shape 12mm | B: Inside round 12mm
C: Straight 13mm | D: Outer round 15mm

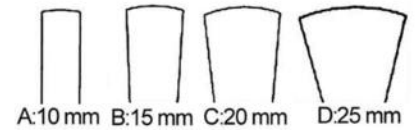

11-01-0636
Lambotte Periosteal Elevator 21.5 cm / 8 1/2"



11-01-0637
Periosteal Elevator 20 cm / 8" with plastic handle



11-01-0638
Periosteal Elevator 17 cm / 6 3/4" with hollow handle

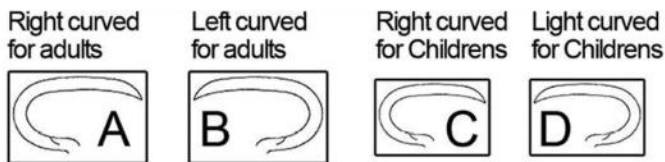

11-01-0639
Doyen Rib Raspatory 17.5 cm / 7" Rib Raspatories with hollow handle

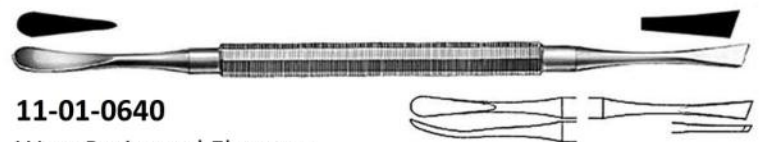

11-01-0640
West Periosteal Elevator,
Double-ended 18.5 cm / 7 1/4" octagonal handle



11-01-0641
Williger Elevator
17 cm / 6 3/4" 7mm tip



11-01-0643
Elevator 17 cm / 6 3/4" Light weight



11-01-0642
Williger Elevator
16 cm / 6 1/4" (5.5mm tip)

PERIOSTEAL ELEVATORS - DISSECTORS

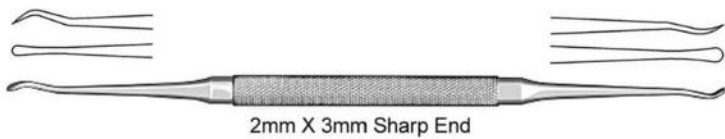

2mm X 3mm Sharp End

11-01-0644

Kleinert Kutz Elevator 14 cm / 5 1/2"



11-01-0645

Vickers Dissector 17 cm / 6 3/4"

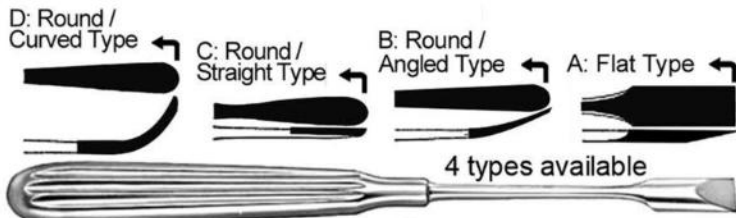

D: Round / Curved Type

C: Round / Straight Type

B: Round / Angled Type

A: Flat Type

4 types available

11-01-0646

Adson Elevator 17.5 cm / 7" A/B/C/D



B: 10mm

A: 8mm

11-01-0647

Langenbeck Elevator 19.5 cm / 7 3/4" A/B

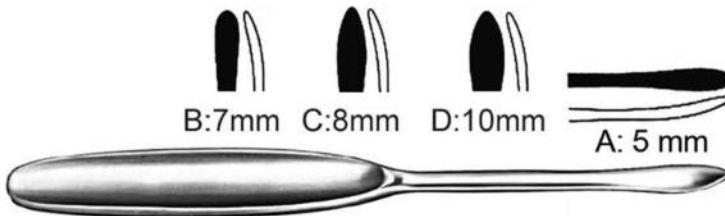

B: 7mm

C: 8mm

D: 10mm

A: 5mm

11-01-0648

Martin Langenbeck Elevator 17 cm / 6 3/4" A/B/C | D: 19.5 cm / 7 3/4"



11-01-0649

Phalangeal Elevator 16cm / 6 1/4"



11-01-0650

Alderdyce Dissector, double-ended 21 cm / 8 1/4"

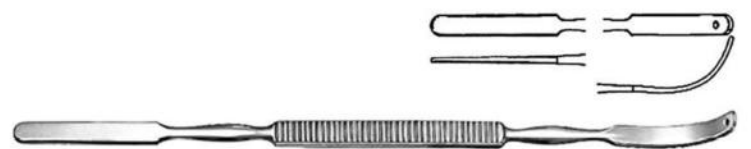

11-01-0651

McDonald Dissector, double-ended 18.5 cm / 7 1/4"



11-01-0652

Freer Elevator 19 cm / 7 1/2"



11-01-0653

Penfield Elevator Endoscopic 38 cm / 15" 5mm Semi Sharp / 1X10mm Blunt Hook



11-01-0654

Smithwick Hook and Dissector 30 cm / 12" 5mm Semi Sharp / 1X10mm Blunt Hook

PERIOSTEAL ELEVATORS - RESPIRATORIES

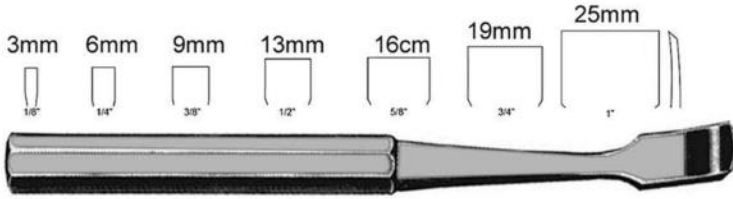

11-01-0655

Key Elevator 19 cm / 7 1/2" Sharp Edge

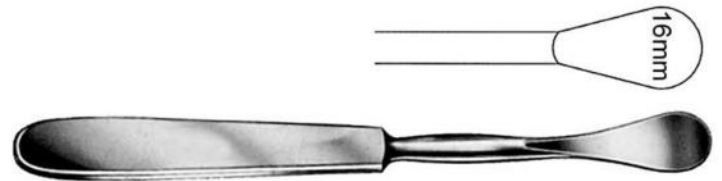

11-01-0656

Sedilot Elevator 18 cm / 7" Sharp Edge



11-01-0657

Alexander Periosteal Respiratory 20 cm / 8" / 12mm Sharp

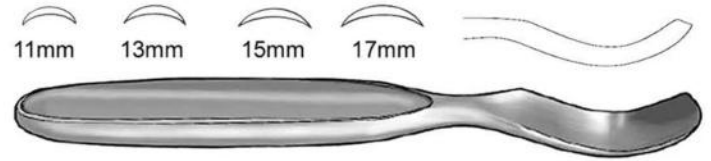

11-01-0658

MeGiamry Metatarsal Elevator 16 cm / 6 1/2" Sharp

- A: 19cm / 7 1/2" 13mm
- B: 20cm / 8" 19mm
- C: 23cm / 9" 25mm
- D: 25.5cm / 10" 30mm

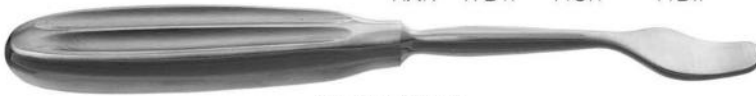
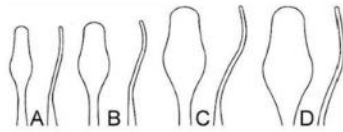

11-01-0659

Chandler Elevator Blunt



11-01-0660

Sayre Elevator 16 cm / 6 1/2"
A: Sharp / Blunt B: Blunt/ Blunt

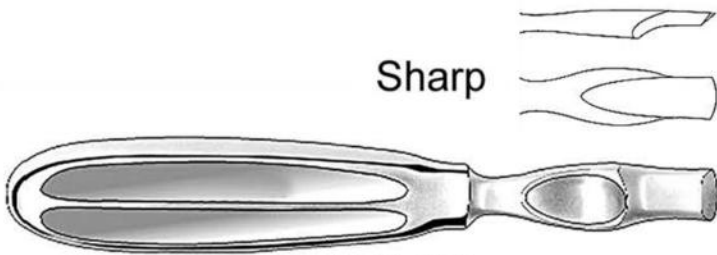

11-01-0661

Kirmission Periosteal Respiratory 17 cm / 6 3/4"

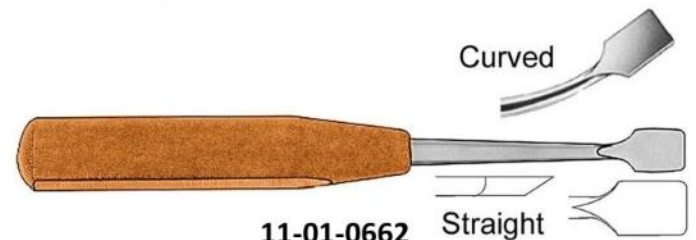

11-01-0662

Periosteal Elevator 17cm / 6 3/4" Fibre Handle
13mm Blade Sharp

- A: 14mm Full Curves
- B: 14mm Slight Curves
- C: 7mm Full Curves
- D: 7mm Slight Curves

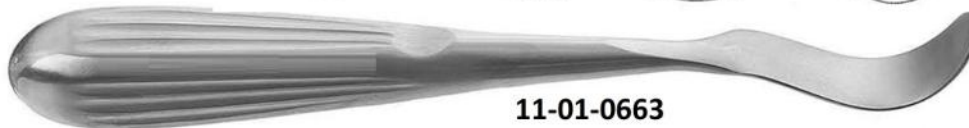
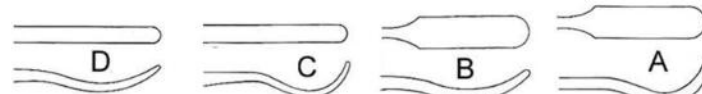

11-01-0663

Crego Periosteal Elevator 19 cm / 7 3/4" Sharp

PERIOSTEAL ELEVATORS - DISSECTORS

Small

A: 26 cm / 10 1/4" 13mm Width at Tip

Medium

B: 26 cm / 10 1/4" 20mm Width at Tip

Large

C: 35 cm / 13 3/4" 25mm Width at Tip

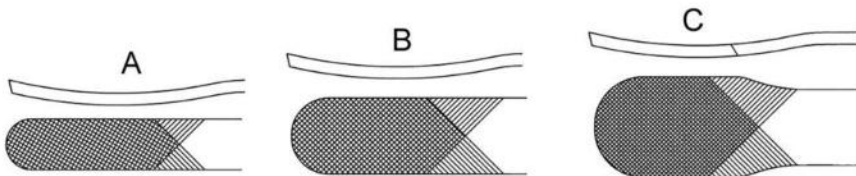

11-01-0664

Darraeh Elevator Blunt

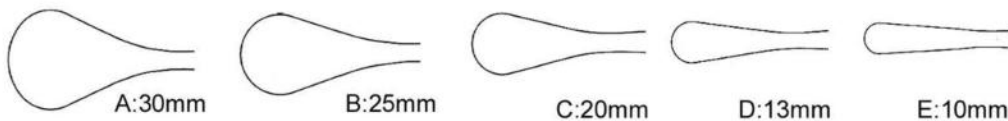

11-01-0665

Cobb Spinal Elevator Sharp 24cm / 9 1/2" Hexa Handle

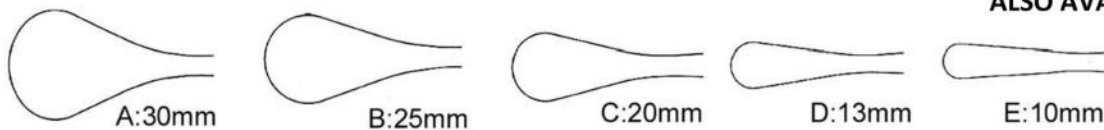

ALSO AVAILABLE WITH FIBRE HANDLE



11-01-0666

Spinal Elevator Sharp 28 cm / 11" Knurled Handle

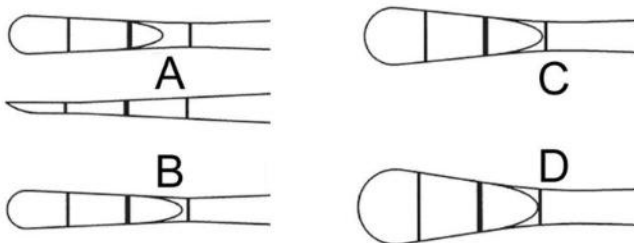

A: 43cm / 17" 6mm Tip Width 2.7" Tip Length 9.3" Shaft Length 5" Handle Length 7.2mm Shaft Dia	B: 50cm / 20" 6mm Tip Width 3 1/2" Tip Length 10" Shaft Length 6 1/2" Handle L 11.5mm Shaft Dia	C: 50cm / 20" 10mm Tip Width 3 1/2" Tip Length 10" Shaft Length 6 1/2" Handle L 11.5mm Shaft Dia	D: 50cm / 20" 13mm Tip Width 3 1/2" Tip Length 10" Shaft Length 6 1/2" Handle L 11.5mm Shaft Dia
----------------------------------------------------------------------------------------------------------------------	-----------------------------------------------------------------------------------------------------------------------	------------------------------------------------------------------------------------------------------------------------	------------------------------------------------------------------------------------------------------------------------



11-01-0667

Cobb Elevator Endoscopic Sharp / Fibre Handle

ELEVATORS SPINAL – S/S & FIBRE

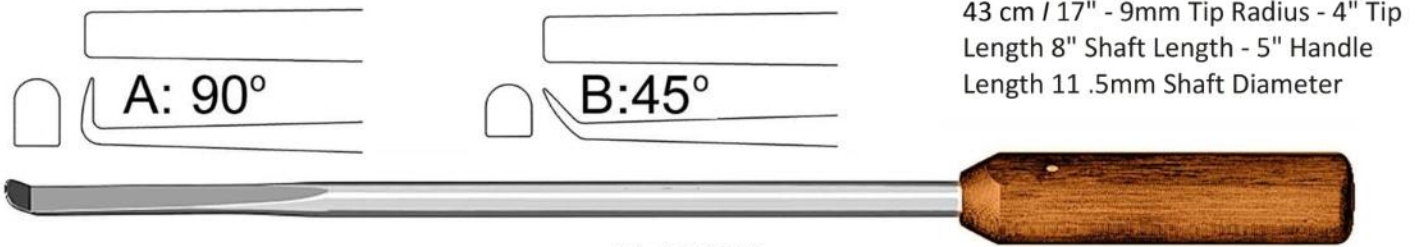

43 cm / 17" - 9mm Tip Radius - 4" Tip Length
8" Shaft Length - 5" Handle Length
11 .5mm Shaft Diameter

11-01-0668

Rib Elevator Endoscopic Sharp / Fibre Handle

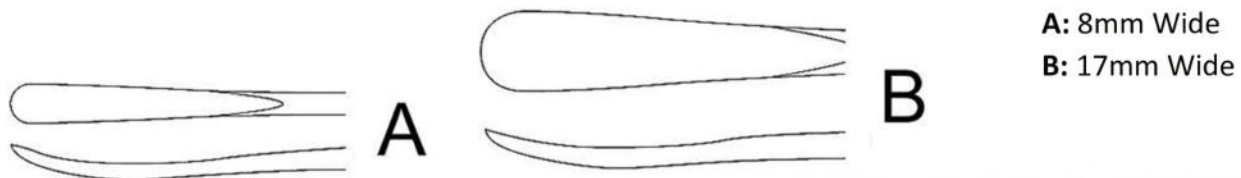

A: 8mm Wide
B: 17mm Wide

11-01-0669

Wagner Elevator Sharp / Fibre Handle 33 cm / 13"

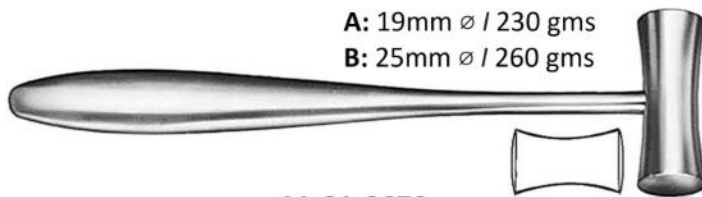

A: 19mm \varnothing / 230 gms
B: 25mm \varnothing / 260 gms

11-01-0670

Lucae Mallet 19.5 cm / 7 3/4"



11-01-0671

Cottle Mallet Plane / Convex
19 cm / 7 1/2" 30mm \varnothing / 300 gms

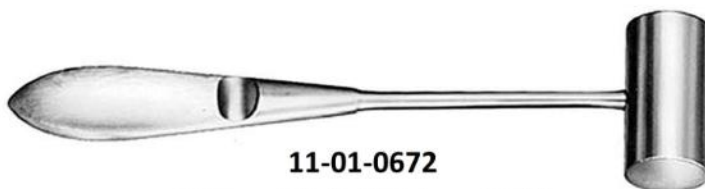

11-01-0672

Williger Mallet 16.4cm / 6 1/2"
20 mm \varnothing / 140 gms



11-01-0673

Mallet 26 cm / 10 1/4"
30 mm \varnothing / 510 gms



27mm \varnothing / 320 gms

11-01-0674

Mead Mallet 19 cm / 7 1/2"
With interchangeable plastic disks



11-01-0675

Partsch Mallet 19 cm / 7 1/2"
With hollow handle 22mm \varnothing / 200 gms

ORTHOPEDIC MALLETS – S/S & FIBRE



11-01-0676
Mallet 26 cm / 10 ¼" with lead filling
42mm ø / 400 gms



11-01-0677
Mallet 26 cm / 10 ¼" without lead filling
42mm ø / 400 gms

- A: 26mm ø / 300 gms
- B: 28mm ø / 340 gms
- C: 30mm ø / 400 gms



11-01-0678
Williger Mallet 24 cm / 9 ½" lead filled
42mm ø / 400 gms



11-01-0679
Mallet 30 mm ø / 675 gms
26.5 cm / 10 ½" plane (Teflon) / convex (steel)



11-01-0680
Mallet 26 cm / 10 ¼"
42 / 30mm ø / 530 gms



11-01-0681
Mallet 24 cm / 9 ½"
30 mm ø / 480 gms



11-01-0682
Mallet 24 cm / 9 ½"
Disks and handle of Fiber 37 mm ø / 370 gms



11-01-0683
Mallet 22 cm / 8 ¾"
30 mm ø / 125 gms



11-01-0684
Mallet 26.5 cm / 10 ½" | 30 mm ø / 450 gms

- A: 20 .5cm / 8" | 25mm ø / 120 gms
- B: 21cm / 8 ¼" | 30mm ø / 180 gms
- C: 21.5cm / 8 ½" | 35mm ø / 260 gms

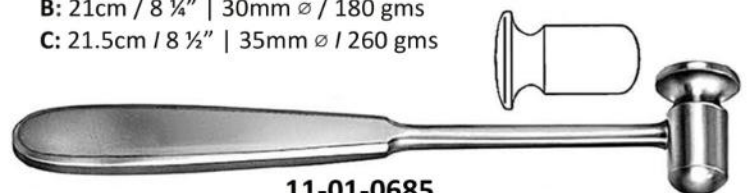

11-01-0685
Doyen Mallet

ELEVATORS SPINAL – S/S & FIBRE



11-01-0686

Herbert Mallet 19 cm / 7 ½"
For ulnar head prosthesis



11-01-0687

Collin Mallet 20 cm / 8"
23 mm ø / 220 gms



11-01-0688

Mallet 26.5 cm / 10 ½"
50 mm ø / 900 gms

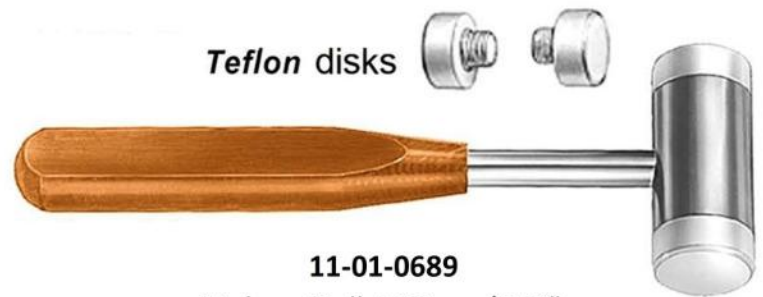

Teflon disks

11-01-0689

Vickers Mallet 19 cm / 7 ½"
25 mm ø / 300 gms



11-01-0690

Kirk Mallet 20cm / 8"
Head Dia 38mm / Weight: 1 lb. 4 oz. (570 grams)



Head Weight: 7 oz (200 grams)

11-01-0691

Gerzog Mallet 19 cm / 7 ½"
Head Dia 25mm / Weight 10 oz (285 grams)



Head Weight: 20 oz (567 grams)

11-01-0692

Heath Mallet 19 cm / 7 ½"
Head Dia 40mm / Weight 2 lbs. (907gm)



Head Weight: 20 oz (567 grams)

11-01-0693

Heath Mallet, SS 18 cm / 7" Solid Frame Handle
Head Dia 40mm / Weight 36 oz. (1020gm)

ELEVATORS SPINAL – S/S & FIBRE



11-01-0694

All Fibre Mallet 24 cm / 9 ½"
Head Dia 80X60mm Weight 14oz. (397gm)



Fibre Handle

11-01-0695

Cloward Mallet 19cm / 7 ½"
Head Dia 20mm / Weight 8oz. (227gm)



11-01-0696

Hajek Mallet 20 cm / 8"
Head Dia 27mm / Weight: 7 oz. (198gm)



Fibre Handle

11-01-0697

Narrow Tip Mallet 20cm / 8"
Head Dia 7mm Weight 6oz. (170gm)

B: Head Dia 35mm Weight 11b 40 oz. (570gm)
C: Head Dia 40mm Weight 11b 90 oz. (708gm)



11-01-0698

Fibre Handle Mallet 23cm / 9"
A: Head Dia 30mm / Weight 12 oz. (340gm)



11-01-0699

He-Man Mallet 28cm / 11"
Head Dia 38mm / 24mm / Weight 21b (906gm)

MENISCUS – TENDON – CARTILAGE INSTRUMENTS

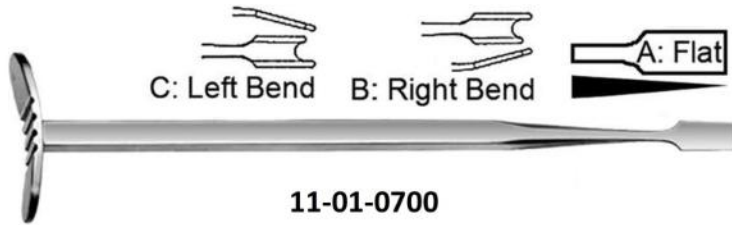

11-01-0700
Smillie Meniscus Knife 18 cm / 7"



11-01-0701
Meniscus Knife 18 cm / 7"

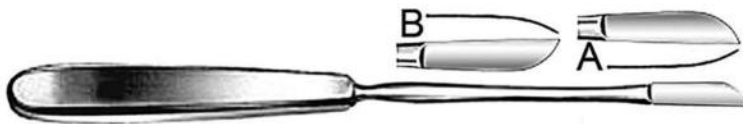

11-01-0702
Neff Meniscus Knife 22 cm / 8 3/4"



11-01-0703
Salenius Meniscus Knife 21 cm / 8 1/4" A: Right / B: Left

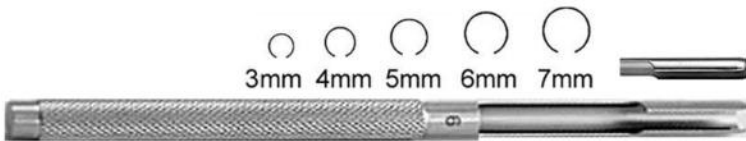

11-01-0704
Bunnell Tendon Stripper 15 cm / 6"



11-01-0705
Fischer Tendon Stripper 31 cm / 12 1/4" Blunt



11-01-0706
Tendon Passing Instrument 33.5 cm / 13 1/4"



11-01-0707
Fischer Tendon Stripper 31 cm / 12 1/4" Blunt



11-01-0708
Tendon Stripper 3 / 4 / 5 / 6mm
A: 28.5 cm / 11 1/4" B: 60 cm / 24"



11-01-0709
Bunnell Tendon Passer 23 cm / 9" Malleable



11-01-0710
Downing Cartilage Knife 25 cm / 10"
Concave Edge Cvd Blade w/ Guards



11-01-0711
Lowe Breck Cartilage Knife 25cm/10" STR Edge-Cvd Blade w / Guards



11-01-0712
Tendon Stripper 40 cm / 16" Fibre Handle

TENDON INSTRUMENTS



11-01-0713

Martin Cartilage Scissors 20cm / 8"

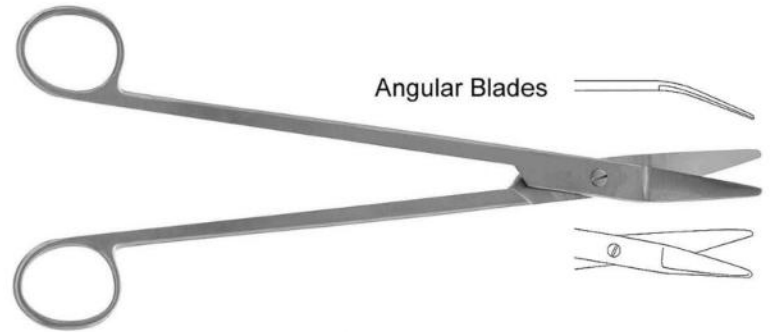

11-01-0714

Mueller Capsule Scissors 24 cm / 9 1/2"

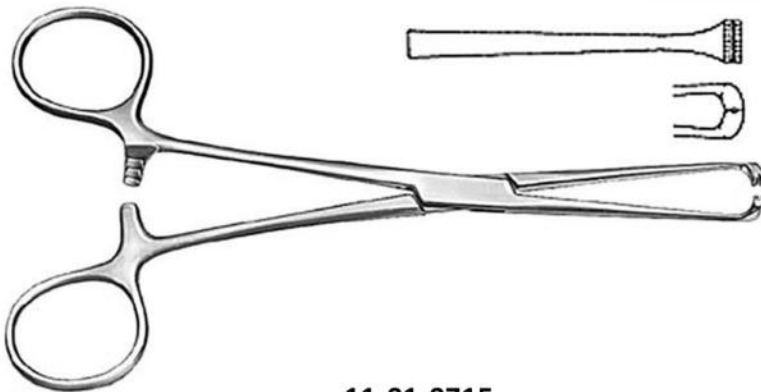

11-01-0715

Steinmann Tendon Holding Forceps 16 cm / 6 1/4"

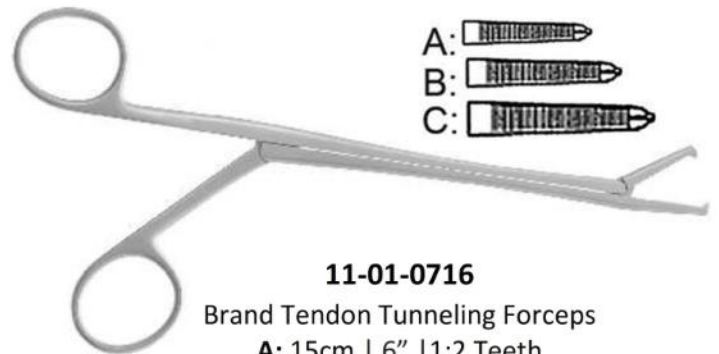

11-01-0716

Brand Tendon Tunneling Forceps

A: 15cm | 6" | 1:2 Teeth

B: 19cm | 7 1/2" | 1:2 Teeth

C: 24.5cm | 9 3/4" | 1:2 Teeth

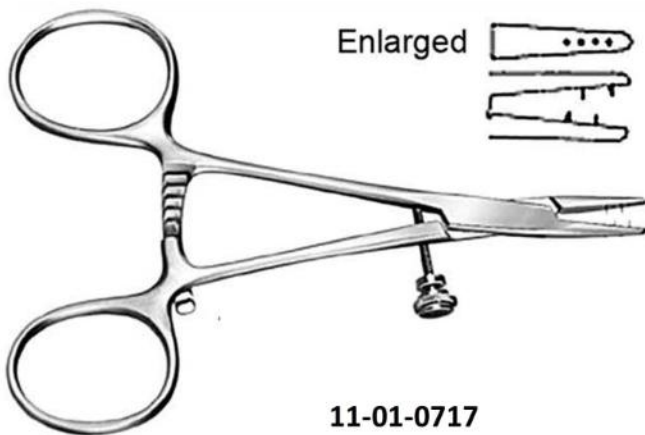

11-01-0717

Tendon Holding Forceps
11.5cm / 4 1/2"

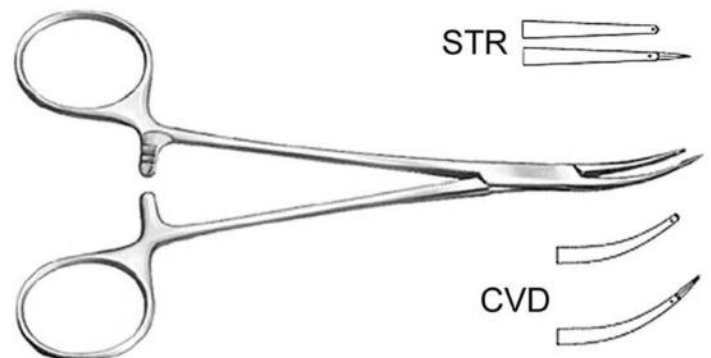

11-01-0718

Tendon Interlacing Forceps
15.5 cm / 6" Pointed

TENDON INSTRUMENTS



11-01-0719-1
Carroll Tendon Holding Forceps
11.5 cm / 4 1/2"

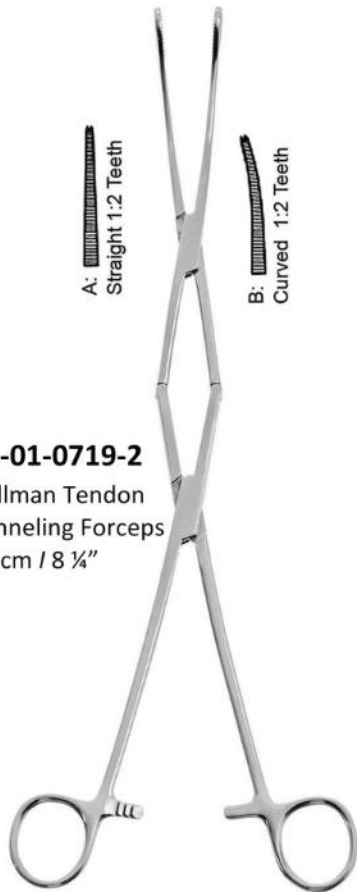

11-01-0719-2
Hallman Tendon Tunneling Forceps
21 cm / 8 1/4"

A: Straight 1:2 Teeth

B: Curved 1:2 Teeth

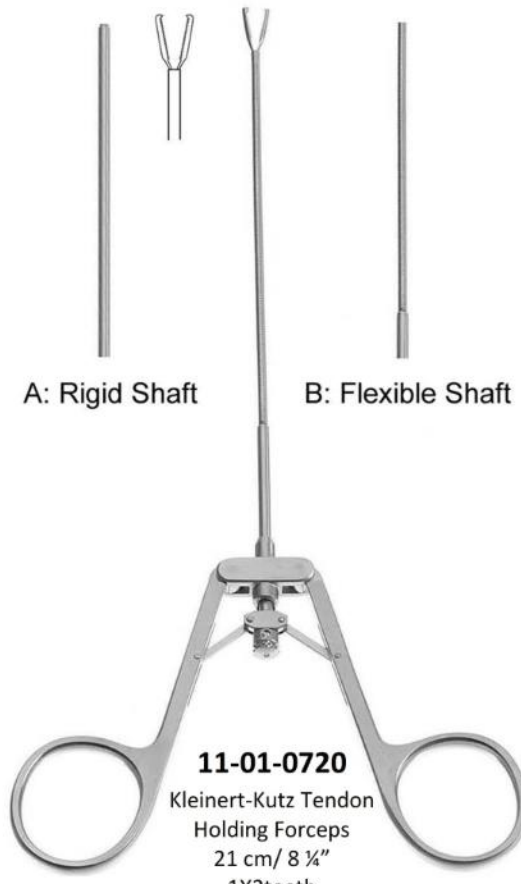

11-01-0720
Kleinert-Kutz Tendon Holding Forceps
21 cm / 8 1/4"
1X2teeth

A: Rigid Shaft

B: Flexible Shaft



11-01-0721
Hoen Grasping Forceps
14 cm / 5 1/2" (Shaft)
1X2 teeth

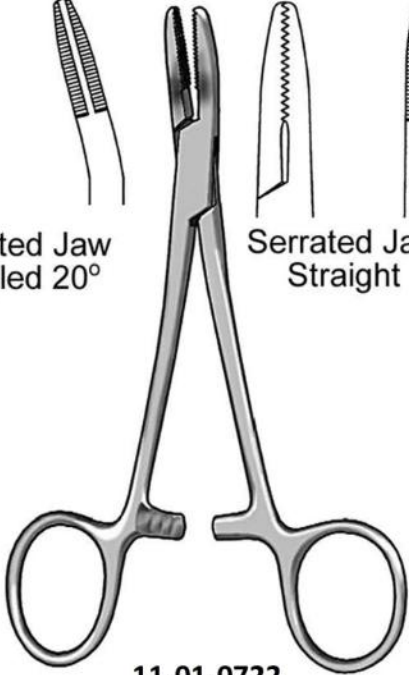
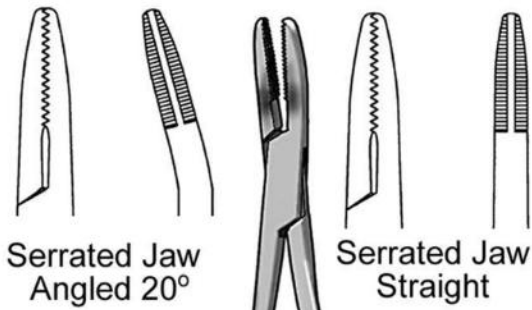

11-01-0722
Meniscus Clamp
13.5 cm / 5 3/8" 1X2 teeth

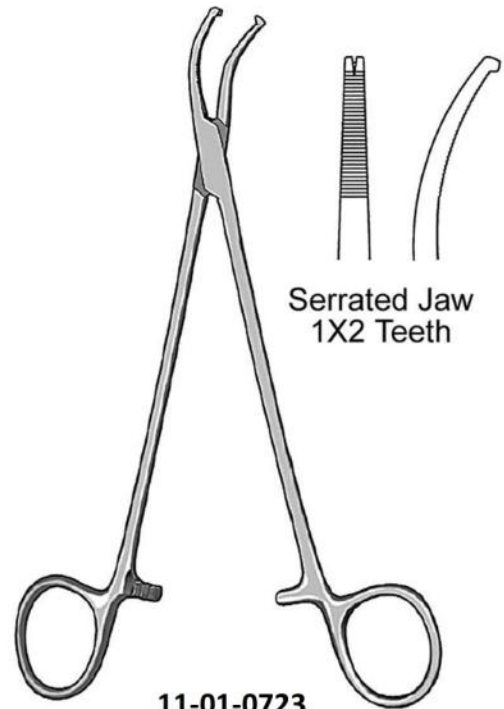

11-01-0723
Preston Ligamentum Flavum Forceps
(Meniscus) 18.5 cm / 7 1/4"



Straight

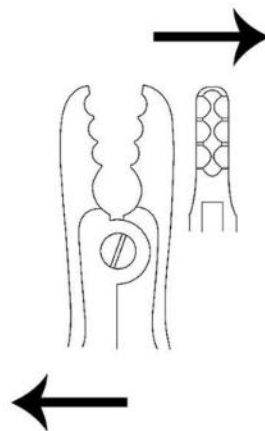

11-01-0724

Ortho Grasper 21 cm / 8 1/2"
7 X 20 MM Bite



Angled

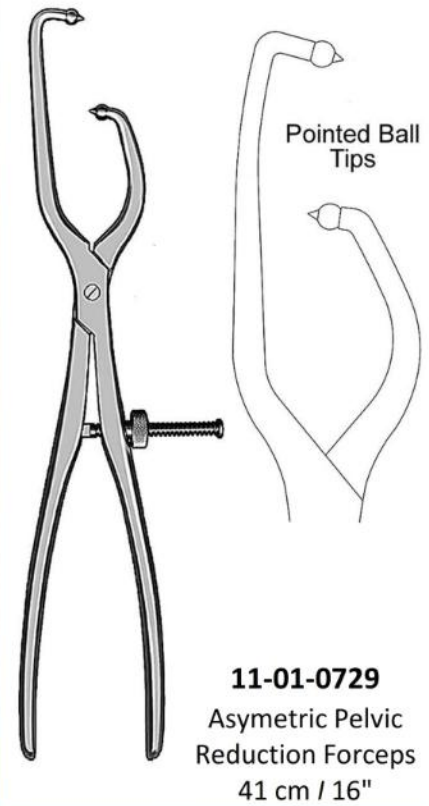
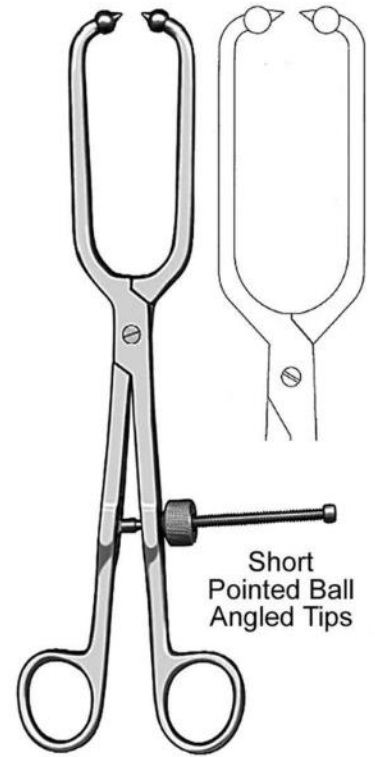
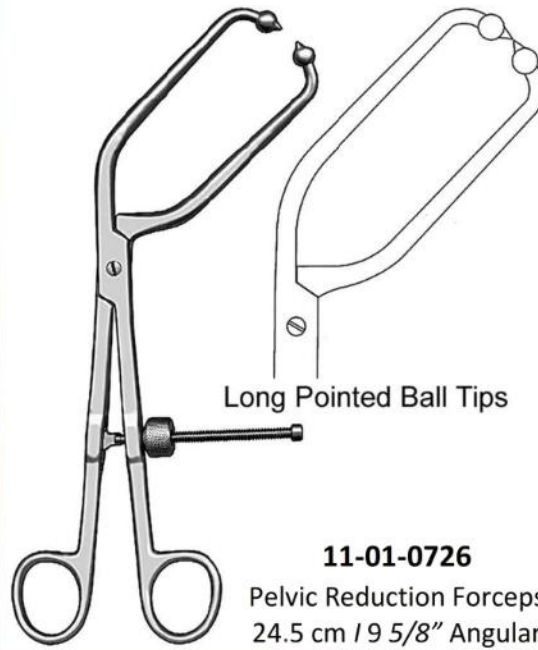
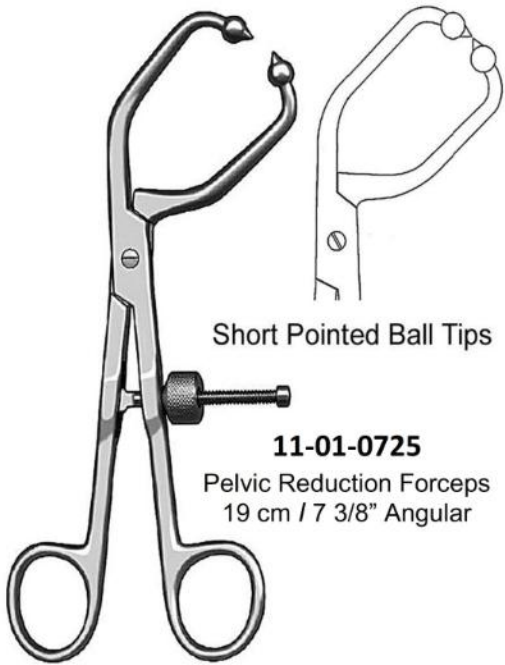

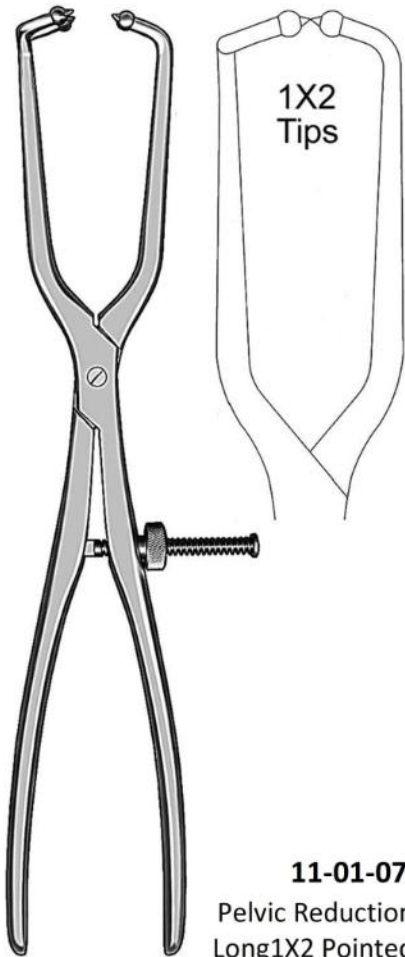

11-01-0730
Pelvic Reduction Forceps
Long 1X2 Pointed Ball Tips
41 cm / 16"

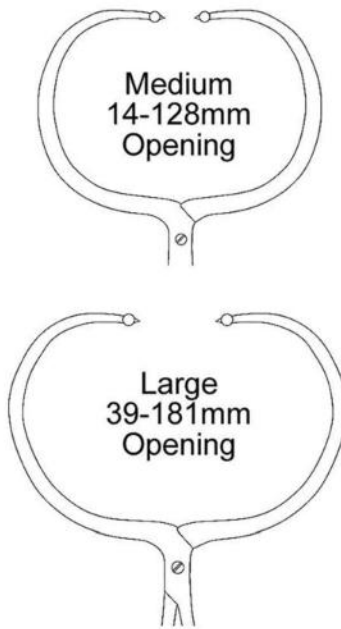

11-01-0731
Periarticular Reduction Forceps
Straight / Pointed Ball Tips
38 cm / 15"



11-01-0732
Pelvic Reduction Forceps
Adjustable Jaws for Screws
A: 25 cm / 10" B: 33 cm / 13"

BONE HOLDING FORCEPS

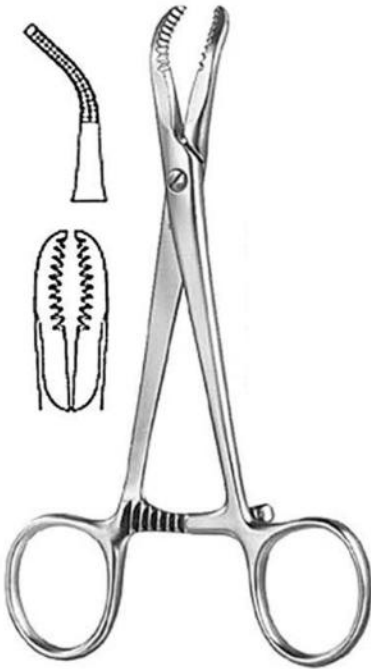

11-01-0733

Bone Holding Forceps
14 cm / 5 1/2"

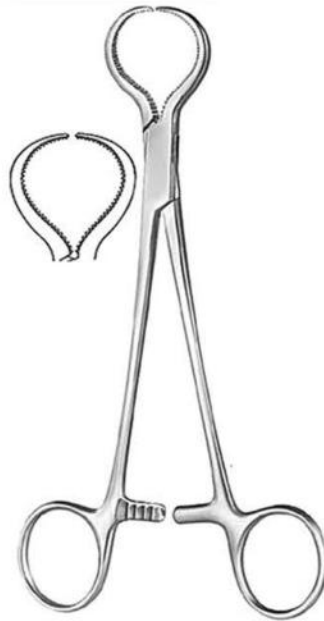

11-01-0734

Lewin Bone Holding Forceps
18.5 cm / 7 1/4"



11-01-0735

Bone Holding Forceps
14 cm / 5 1/2" Delicate



11-01-0736

Frosch Bone Holding Forceps 18 cm / 7"



11-01-0737

Bone Holding Forceps 20 cm / 8"



11-01-0738

Semb Bone Holding Forceps 19 cm / 7 1/2"



11-01-0739

Lengenbeck Bone Holding Forceps 21 cm / 8 1/4"



11-01-0740

Fergusson Bone Holding Forceps Heavy pattern



11-01-0741 A: 23 cm / 9" B: 26 cm / 10 1/4"

Farabeuf Bone Holding Forceps

BONE HOLDING FORCEPS



11-01-0742
Kern Bone Holding Forceps
A: 17 cm / 6 ³/₄"
B: 21 cm / 8 ¹/₄"

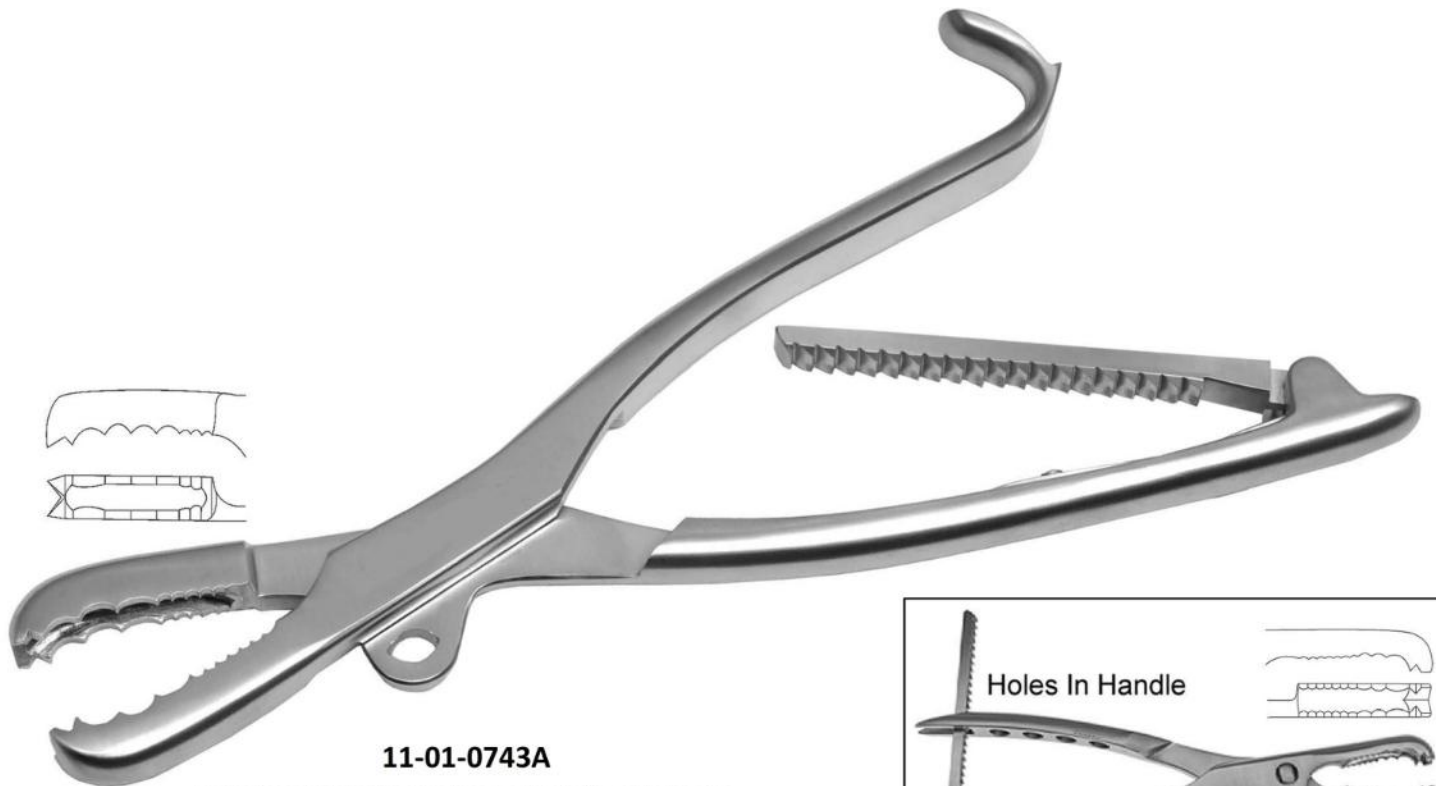

11-01-0743A
Farabeuf Lambotte Bone Holding Forceps
A: 23 cm / 9" | **B:** 26 cm / 10"
Adjustable / with Ratchet



11-01-0743B

BONE HOLDING FORCEPS

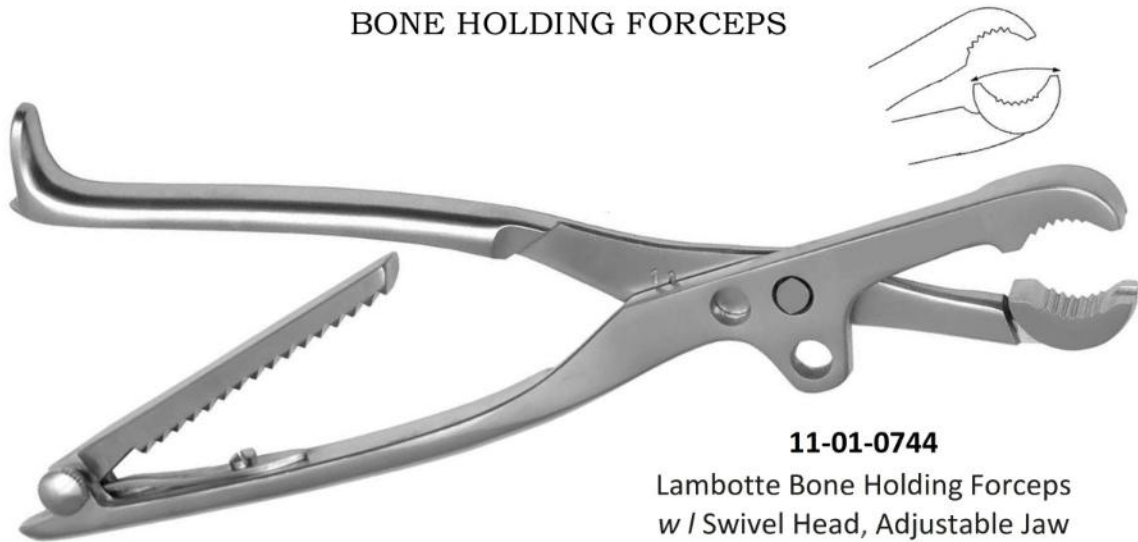

11-01-0744

Lambotte Bone Holding Forceps
w / Swivel Head, Adjustable Jaw

A: 22 cm | 8 ¾" | **B:** 27 cm | 10 ¾" | **C:** 30 cm | 11 ¾"



11-01-0745

Ulrich Bone Holding Forceps
w / Thread Fixation 19 cm / 7 ¼"

11-01-0746
Ulrich Bone Holding Forceps
w / Thread Fixation
A: 23 cm / 9" | **B:** 25 cm / 9 ¾" | **C:** 28 cm / 11"

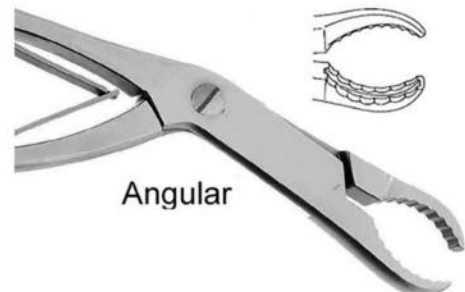

Angular

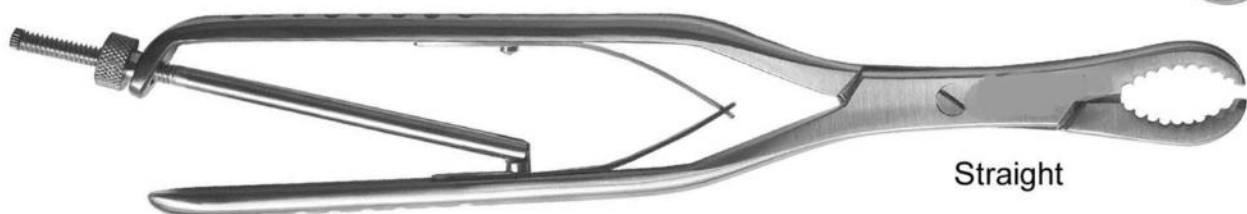

Straight

BONE HOLDING FORCEPS

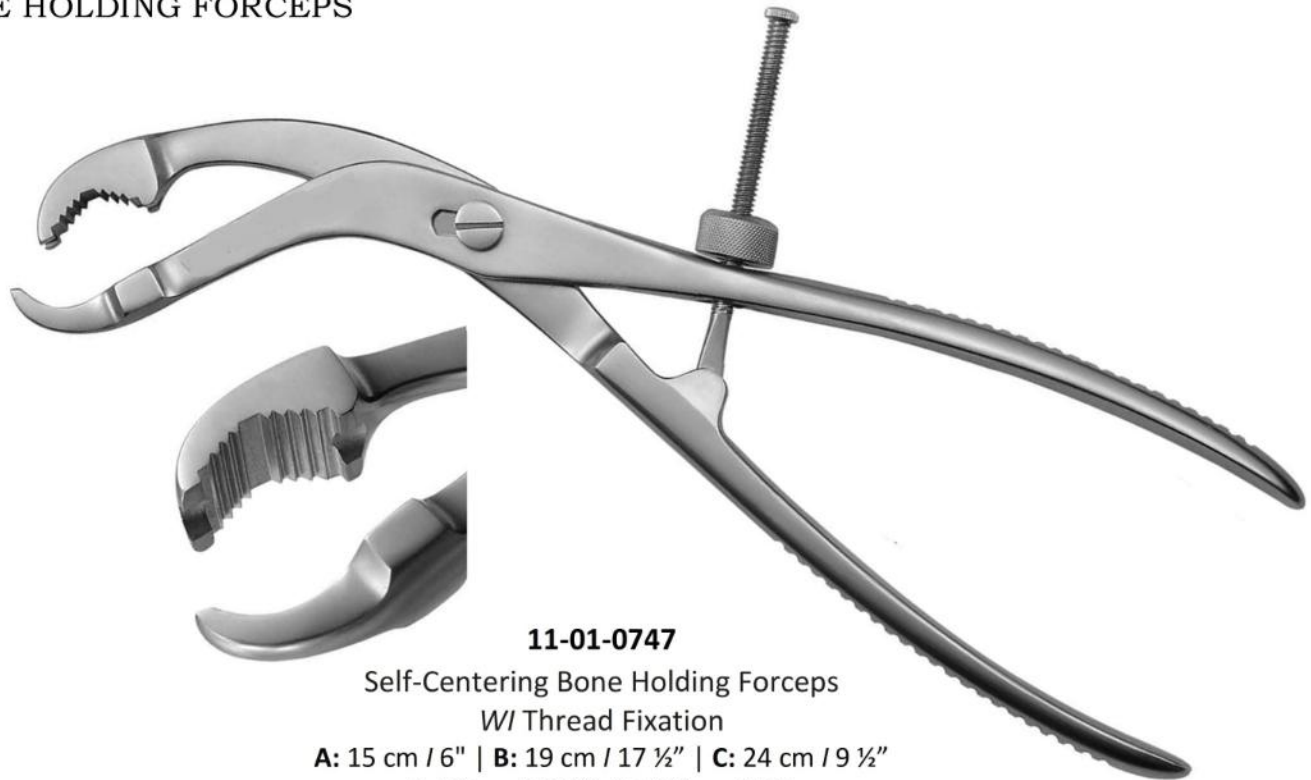

11-01-0747

Self-Centering Bone Holding Forceps
W/ Thread Fixation

A: 15 cm / 6" | B: 19 cm / 17 1/2" | C: 24 cm / 9 1/2"
D: 26 cm / 10 1/4" | E: 28 cm / 11"



11-01-0748

Lane Bone Holding Forceps w / Ratchet

A: 33 cm / 13"
B: 45 cm / 17 3/4"

11-01-0749

Without Ratchet

BONE HOLDING FORCEPS



11-01-0750

Hey Groves Bone Holding Forceps

A: 20 cm / 8" | B: 25 cm / 10" | C: 30 cm / 12"



11-01-0751

Verbrugge Bone Holding Forceps

A: 17.5 cm / 7" | B: 25 cm / 9 ¾"
C: 26 cm / 10 ¼" | D: 27 cm / 10 ¾"



11-01-0752

Smooth Jaws Bone Holding Forceps

23 cm / 9"

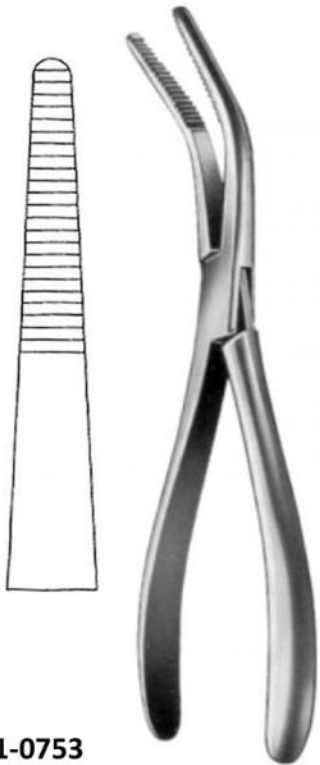

11-01-0753
Van Buren Bone Holding Forceps
21.5 cm / 8 1/2"

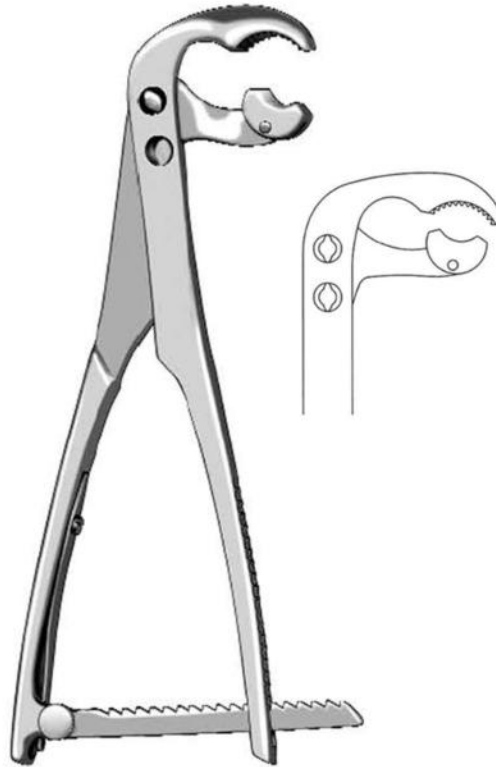

11-01-0754
Angled Bone Holding Forceps 23 cm / 9"



11-01-0755
Bishop Bone Holding Forceps 23 cm / 9"



11-01-0756
Bone Holding Forceps
A: 17cm 6 3/4" 0.9mm
B: 13cm 5 1/4" 1.6mm

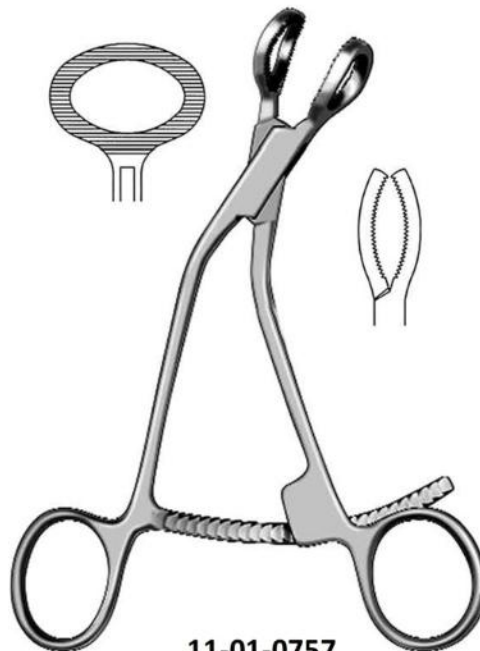

11-01-0757
Bishop Bone Holding Forceps
23 cm / 9"

1X2 Prong



2X2 Prong

11-01-0758
Patella Forceps 18 cm / 7"

BONE HOLDING FORCEPS



11-01-0759

Hayton Williams Forward Traction Forceps
Broad Tips 23 cm / 9"



11-01-0760

Fibula Bone Holding Forceps
21 cm / 8 1/2"



11-01-0761

Bone Holding Forceps
w/ Thread Fixation
15 cm / 6"



11-01-0762-1

Semb Bone Holding Forceps
Curved Sideward
21 cm / 8 1/2"



11-01-0762-2

Bargo Bone Holding Forceps 15 cm / 6"

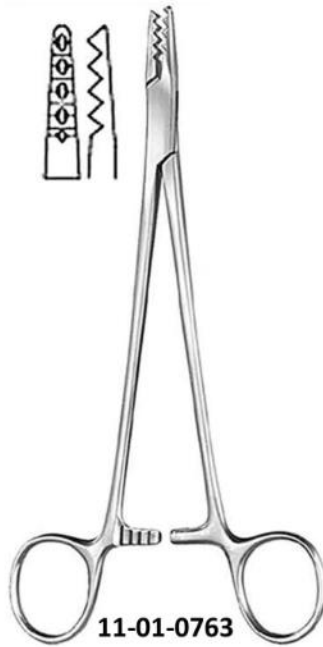

11-01-0763

Martin Cartilage Seizing Forceps
18.5 cm / 7 1/4"

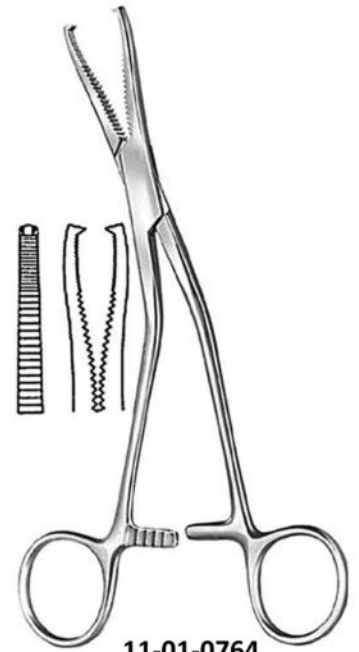

11-01-0764

Dingmann Cartilage Seizing Forceps
18.5 cm / 7 1/4"



11-01-0765

Reposition Forceps
13.5 cm / 5 1/4" Long ratchet pointed



11-01-0766

Reposition Forceps
15 cm / 6" Long Ratchet Pointed

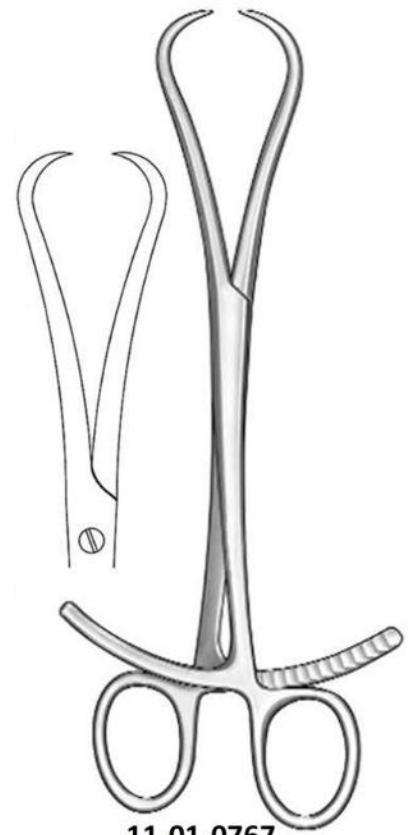

11-01-0767

Walton Bone Reduction Forceps
20.5 cm / 8" | 2" Double Ratchet
Opening 9-100mm

REPOSITION – CARTILAGE FORCEPS

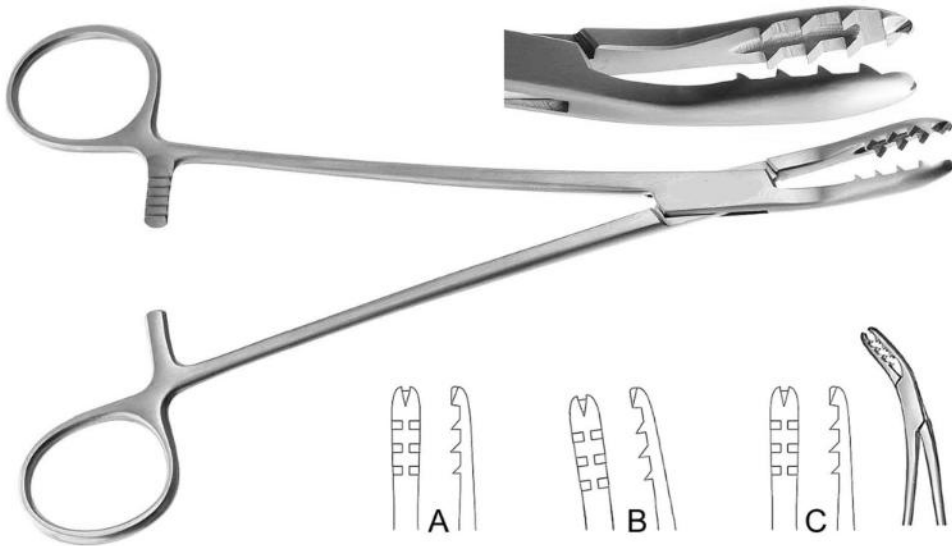

11-01-0768

Cartilage Seizing Forceps

A: Straight | B: Upward Cvd | C: Sideward Cvd

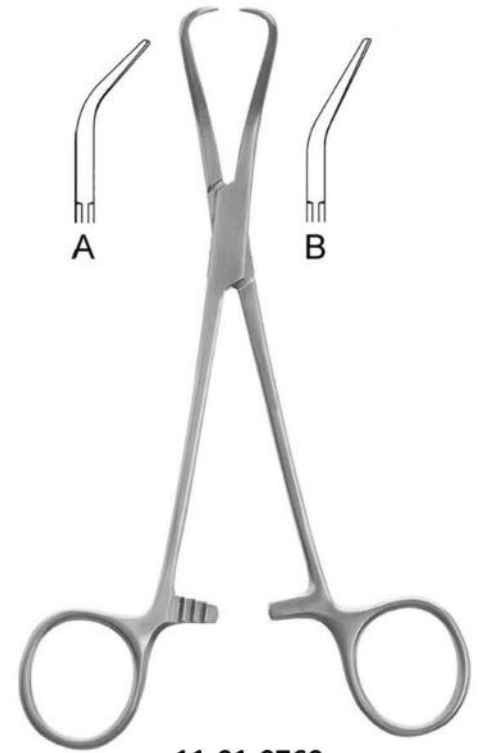

11-01-0769

Glenoid Perforating Forceps 17cm / 6 ½"

A: Strong Cvd | B: Slight Cvd



11-01-0770

Bone Reposition Forceps
w / Thread Fixations Screw

A: 17 cm / 6 ¾"

B: 24 cm / 9 ½"



11-01-0771

Reill Bone Reduction Forcep

17.5 cm / 7"

BONE CUTTING FORCEPS

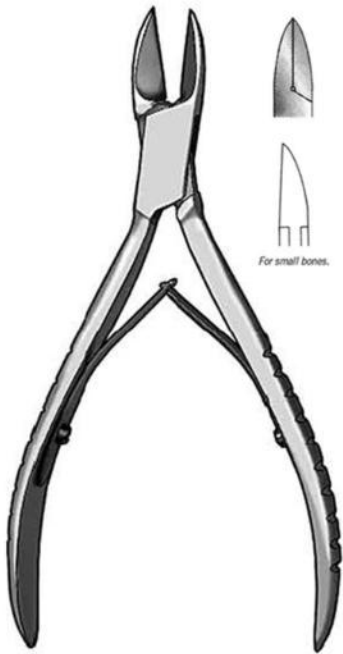

11-01-0772
Littauer Bone Cutting Forceps
15 cm / 6"



11-01-0773
Marwalder Bone Nipper
18.5 cm / 7 1/4"



11-01-0774
Cottle Kazanjian Bone Cutting
Forceps 18.5 cm / 7 1/4"

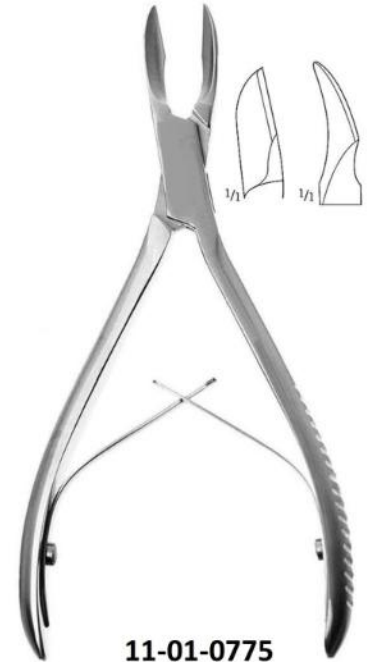

11-01-0775
Cleveland Bone Cutting Forceps
A: 14.5 cm / 5 3/4"
B: 17 cm / 6 3/4"

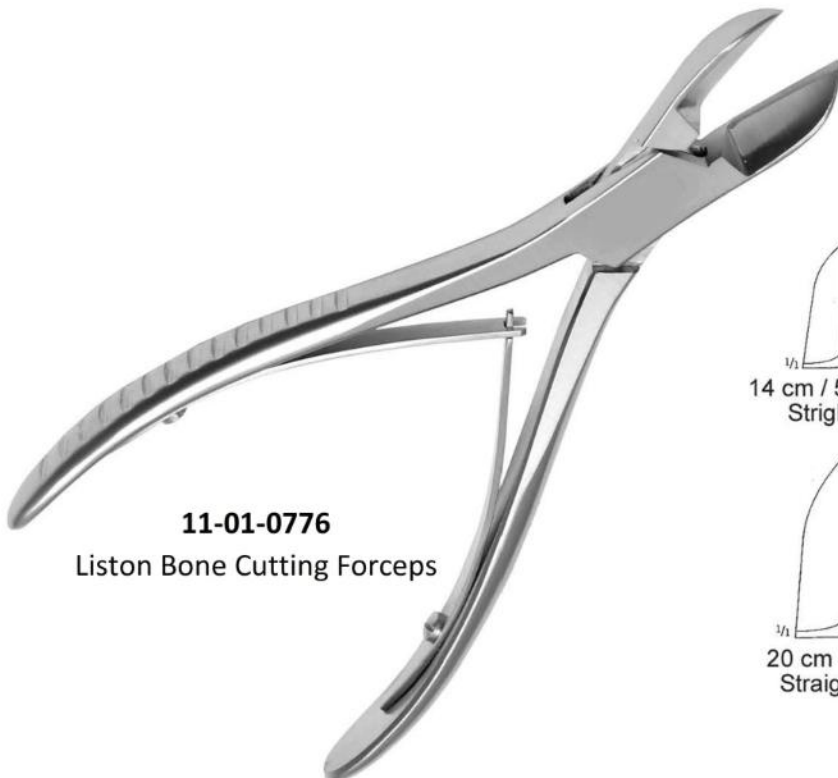

11-01-0776
Liston Bone Cutting Forceps

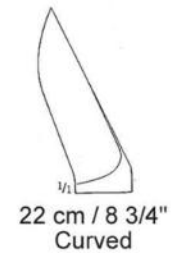
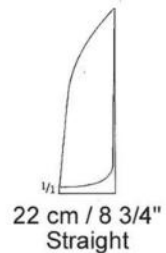
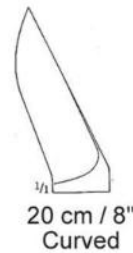
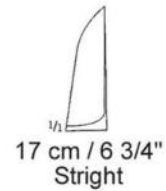

BONE CUTTING FORCEPS

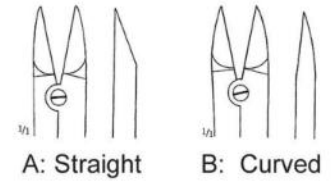

11-01-0777

Kleinert-Kutz / Bohler Bone Cutting Forceps 14.5 cm / 5 ¾"

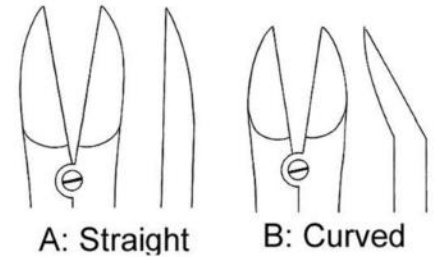
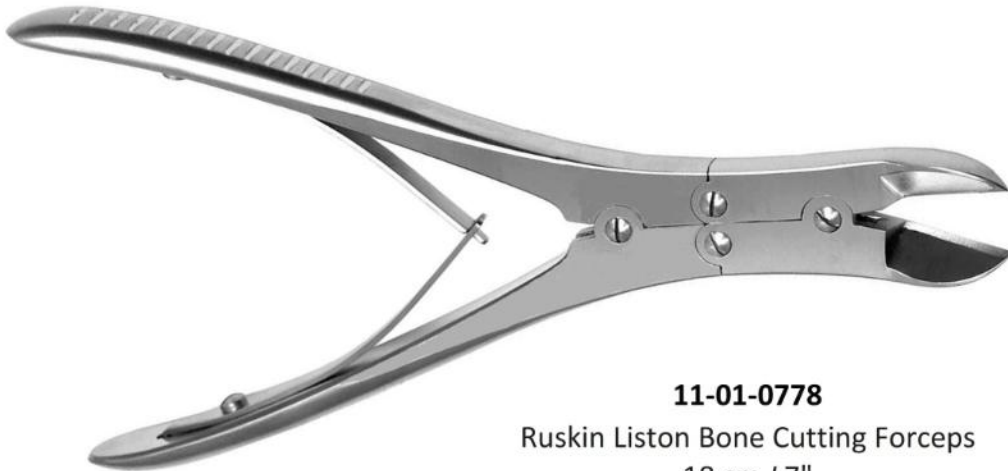

11-01-0778

Ruskin Liston Bone Cutting Forceps 18 cm / 7"

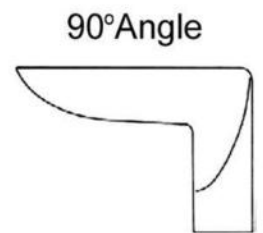

11-01-0779

Stille-Liston Bone Cutting Forceps 26 cm / 10 ¼"

BONE CUTTING FORCEPS

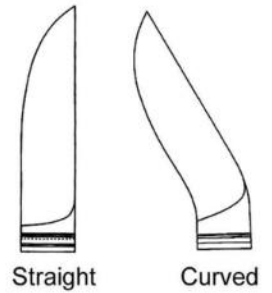

11-01-0780

Stille-Liston Bone Cutting Forceps
A: 23 cm / 9" | B: 27.5 cm / 10 3/4"



11-01-0781

Cleveland Bone Cutting Forceps
16 cm / 6 1/4"

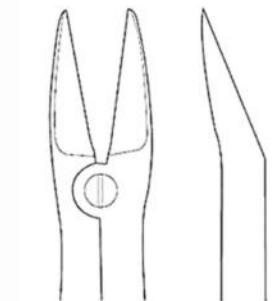

11-01-0782

Me Indoe Bone Cutting Forceps
18 cm / 7" Delicate Blades

BONE CUTTING FORCEPS

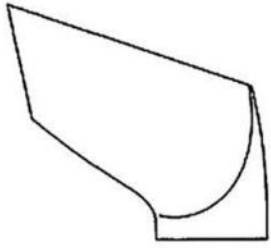

45° Angled

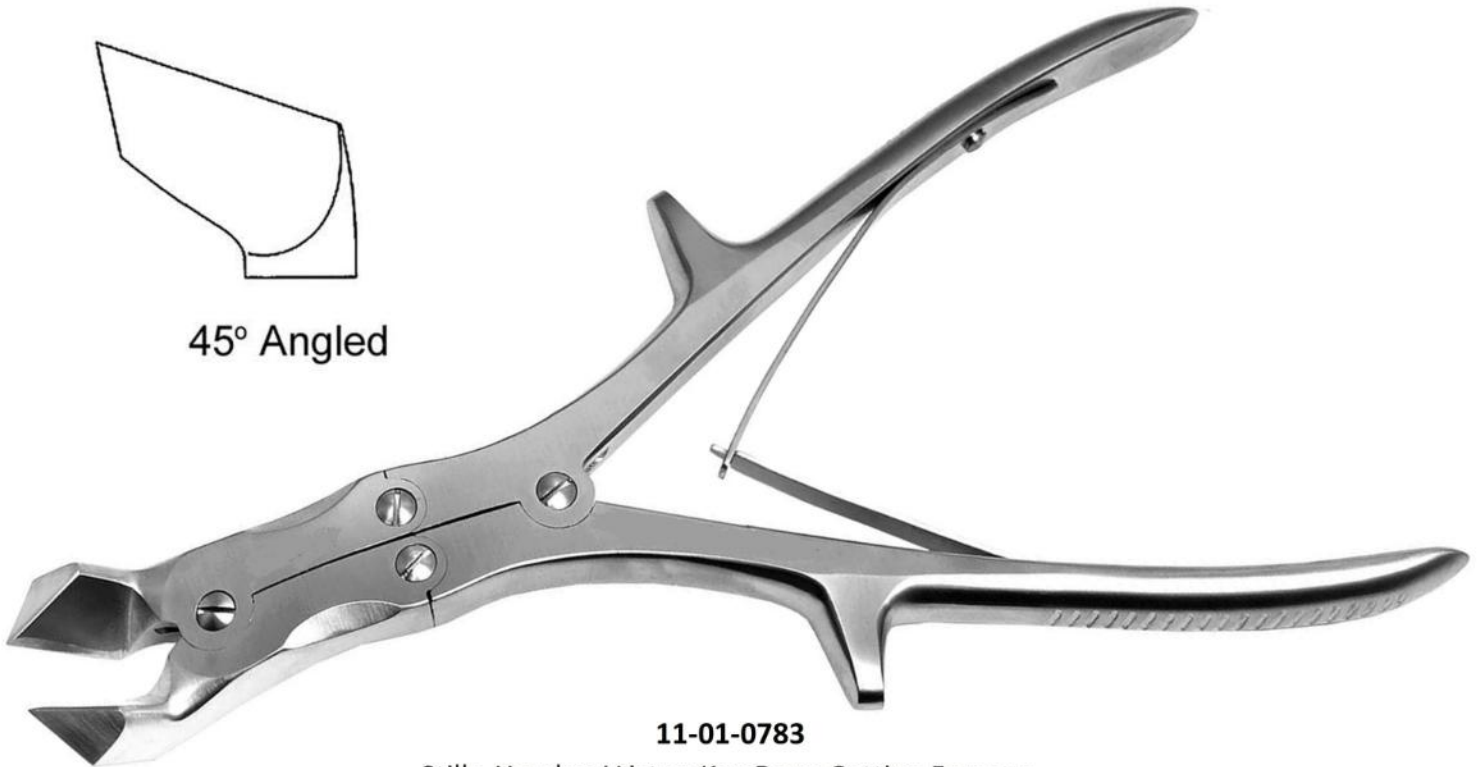

11-01-0783

Stille-Horsley / Liston Key Bone Cutting Forceps
25.5 cm / 10"

90° Angled

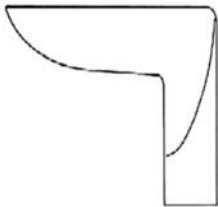

Angled On Side

11-01-0784

Semb Bone Cutting Forceps
24.5 cm / 9 3/4"

BONGE RONGEURS - NIBBLERS

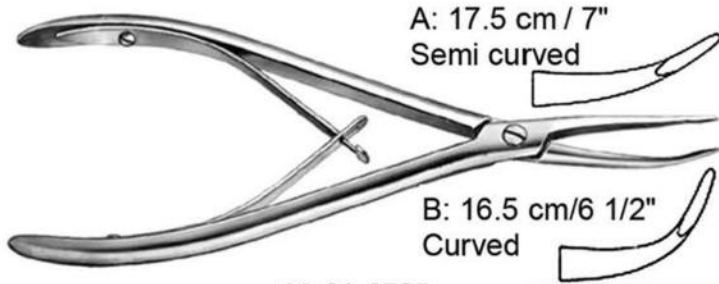

11-01-0785
Stellbrink Bone Rongeur



11-01-0786
Friedmann Bone Rongeur
A: 12.5 cm / 5" | B: 13.5 cm / 5 1/4"



11-01-0787
Friedmann Bone Rongeur
13.5 cm / 5 1/4"



11-01-0788
Cleveland Bone Rongeur
A: 13.5 cm / 5 1/4" | B: 16.5 cm / 6 1/2"



11-01-0789
Mead Bone Rongeur 16.5 cm / 6 1/2"

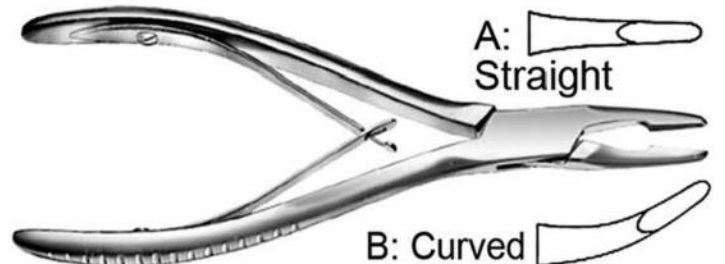

11-01-0790
Jansen Bone Rongeur 18 cm / 7"



11-01-0791-1
Luer Bone Rongeur 14.5 cm / 5 3/4"

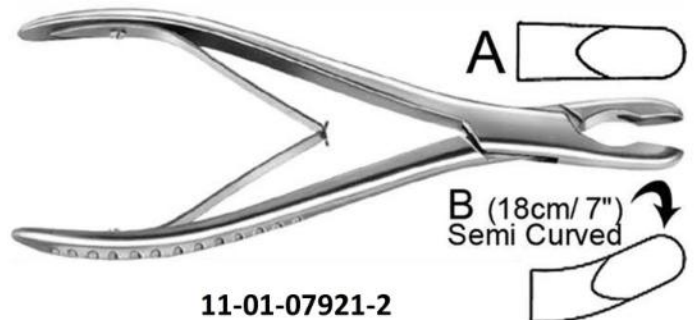

11-01-07921-2
Luer Bone Rongeur 18.5 cm / 7 1/4"

BONGE RONGEURS - NIBBLERS

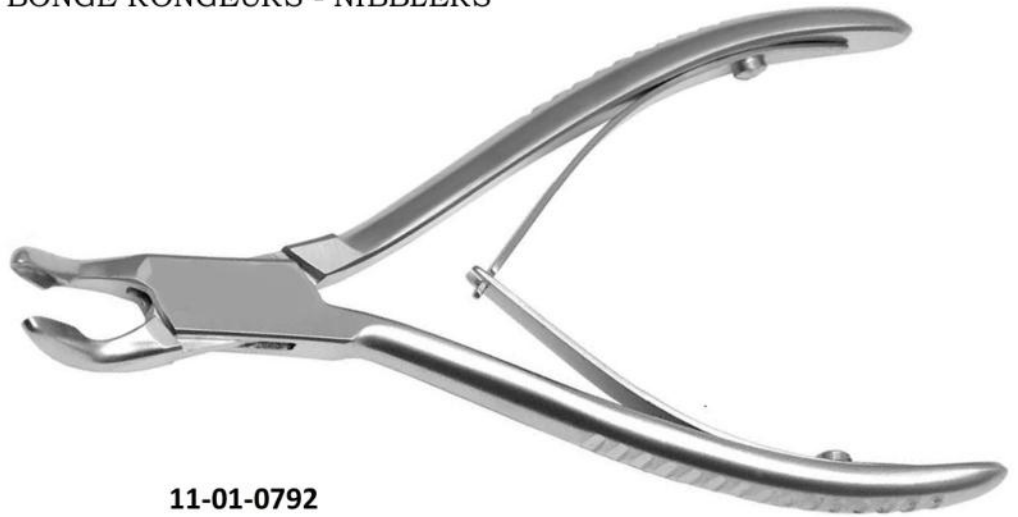
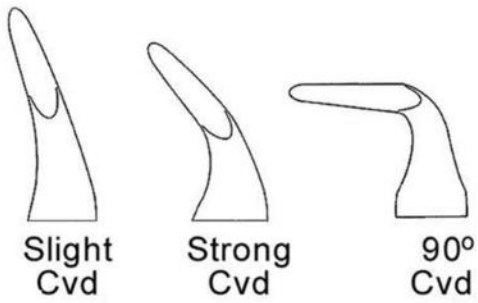

11-01-0792
Blumental Bone Rongeur 12.5 cm / 5"

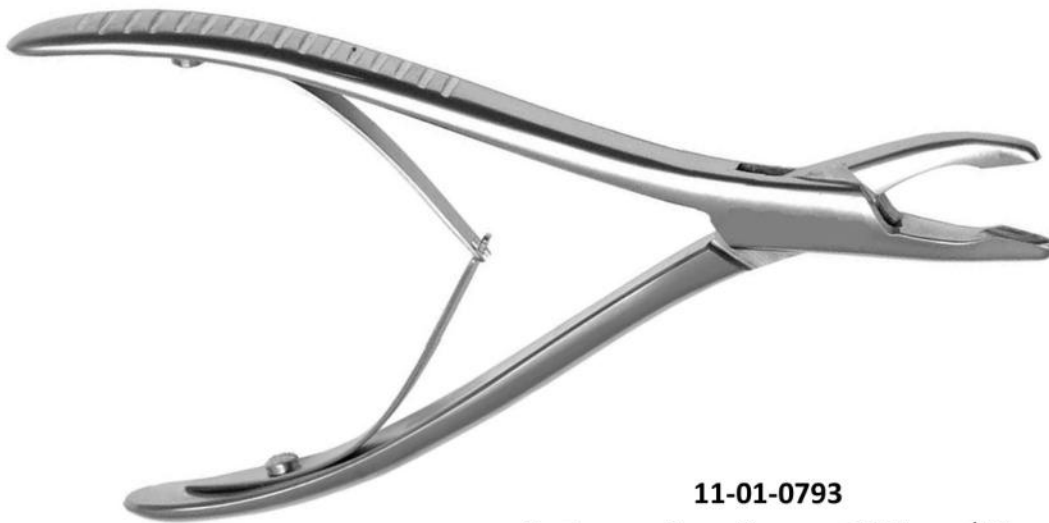

11-01-0793
Hartmann Bone Rongeur 17.5 cm / 7"



4mm



11-01-0794
Jansen Bone Rongeur 19 cm / 7 1/2" Bayonet

BONGE RONGEURS - NIBBLERS



11-01-0795

Jansen Bone Rongeur Straight

A: 14 cm / 5 ½"

B: 17 cm / 6 ½"



11-01-0796

Jansen Bone Rongeur Delicate

14 cm / 5 ½"

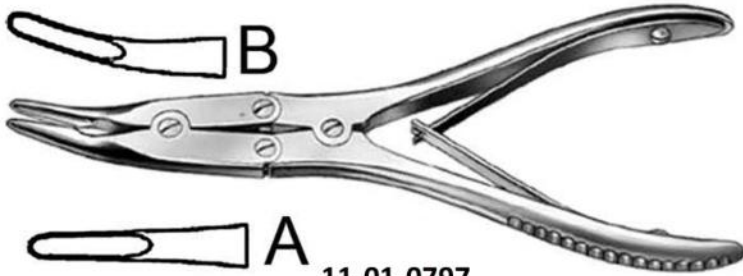

11-01-0797

Bohler Bone Rongeur 15.5 cm / 6"



11-01-0798

Beyer Bone Rongeur 18 cm / 7"



11-01-0799

Zaufai-Jansen Bone Rongeur 18 cm / 7"



11-01-0800

Mayfield Bone Rongeur 18 cm / 7"



11-01-0801

Marquard Bone Rongeur 20.5 cm / 8"



11-01-0802

Lempert Bone Rongeur 19 cm / 7 ½"

BONGE RONGEURS - NIBBLERS



11-01-0803
Stille Bone Rongeur
22.5 cm / 8 ¾"

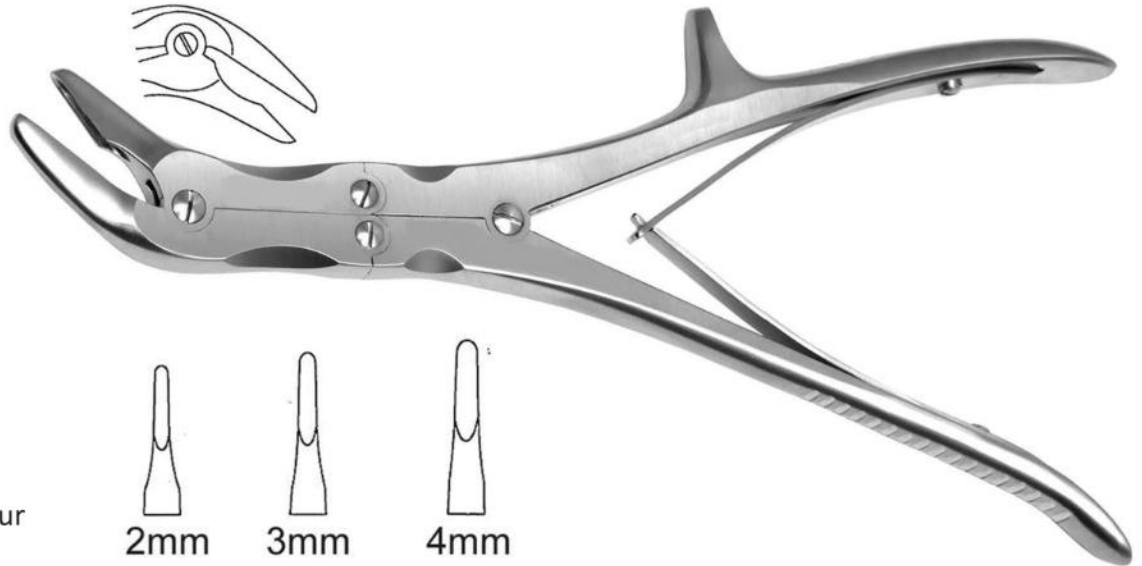

11-01-0804
Echlin Duckbill Bone Rongeur
22 cm / 8 ¾"

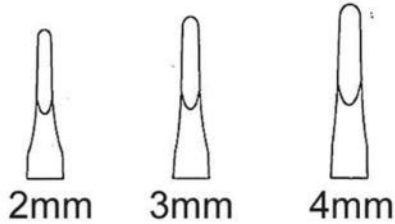

11-01-0805
Ruskin Bone Rongeur
18 cm / 7"

BONGE RONGEURS - NIBBLERS



11-01-0805
Ruskin Bone Rongeur
24 cm / 9 ½"

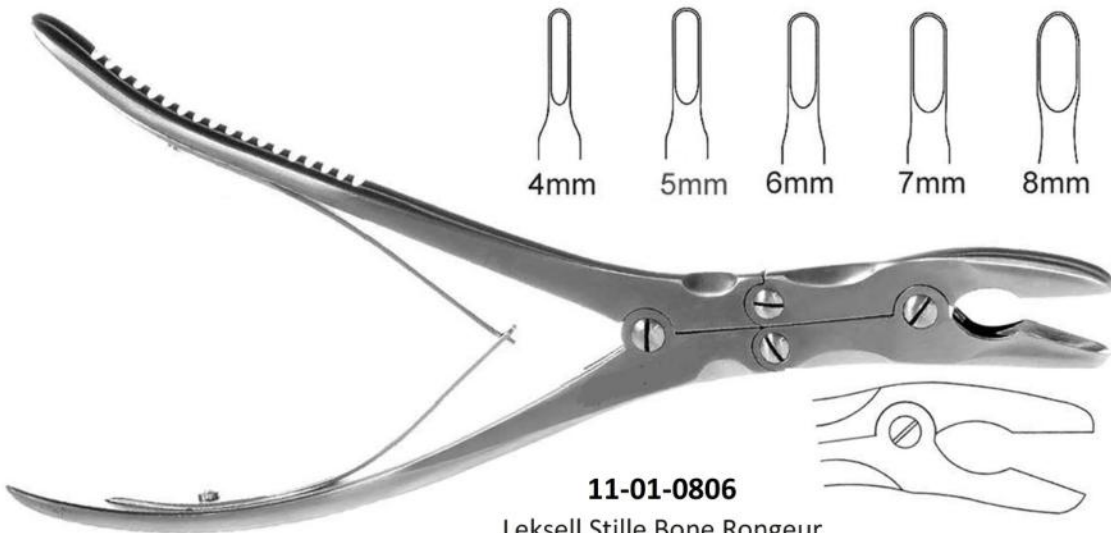

11-01-0806
Leksell Stille Bone Rongeur
24 cm / 9 ½"

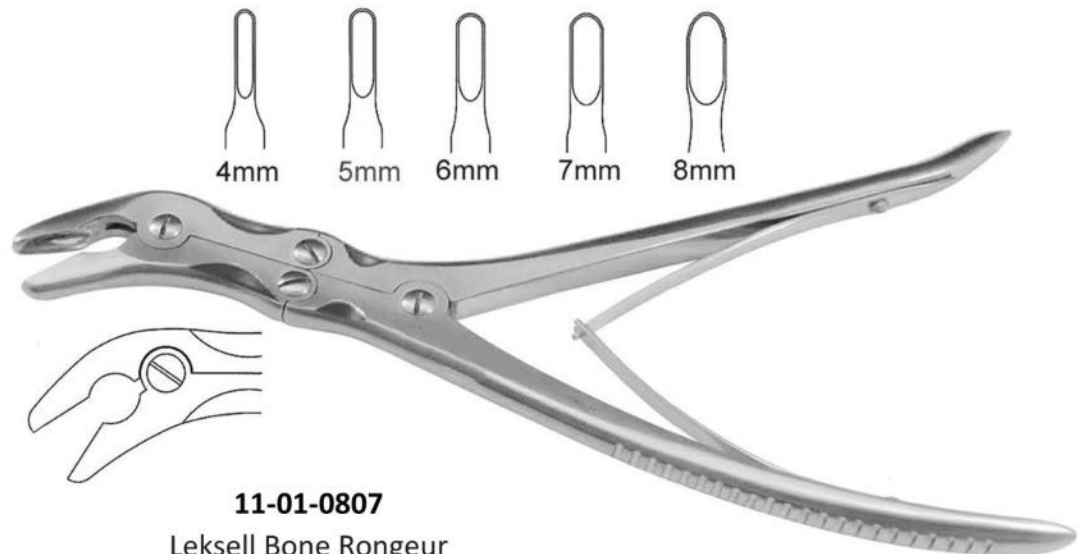

11-01-0807
Leksell Bone Rongeur
24 cm / 9 ½"

BONGE RONGEURS - NIBBLERS



11-01-0808
Leksell Bone Rongeur
23 cm / 9"

- A: Straight
- B: Slight Curved
- C: Strong Curved
- D: Extra Strong Cvd

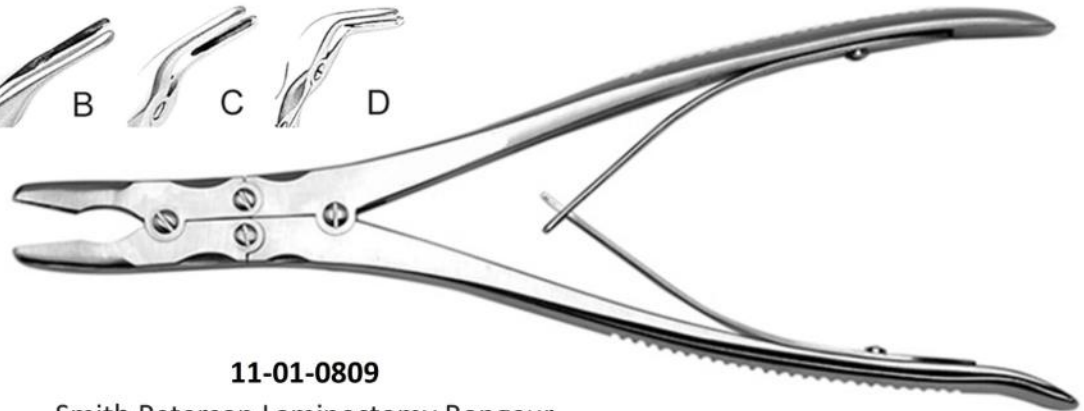

11-01-0809
Smith Peterson Laminectomy Rongeur
24 cm / 9 1/2"

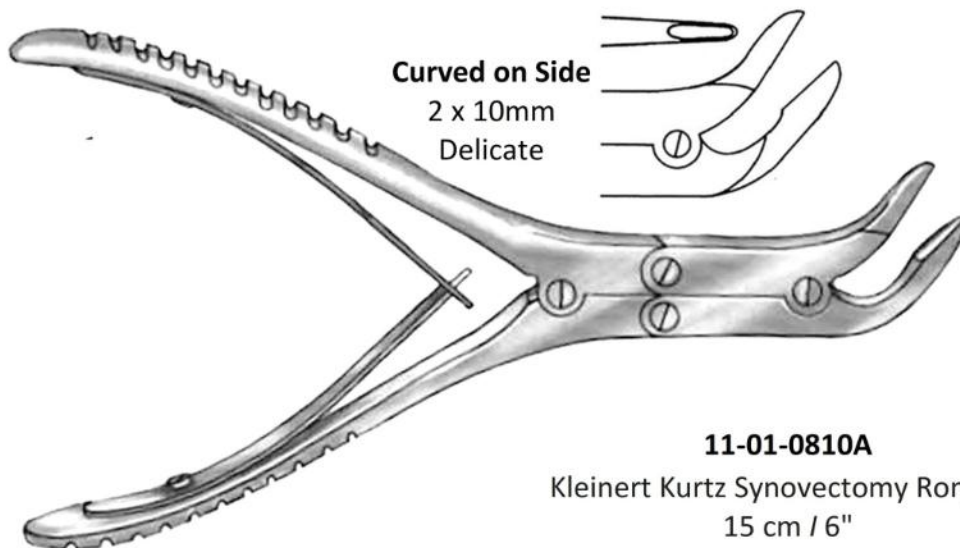

Curved on Side
2 x 10mm
Delicate

11-01-0810A
Kleinert Kurtz Synovectomy Rongeur
15 cm / 6"

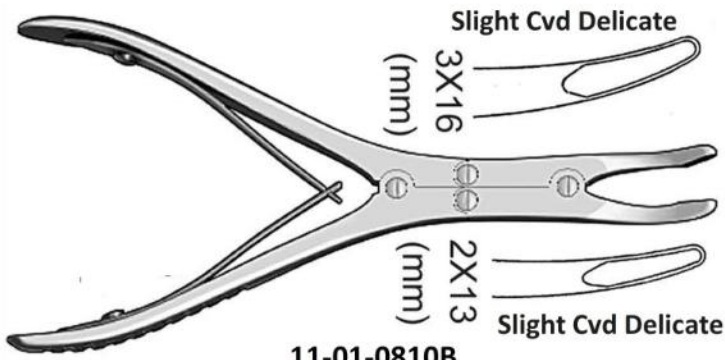

11-01-0810B

Kleinert Kurtz Synovectomy Rongeur 15 cm / 6"

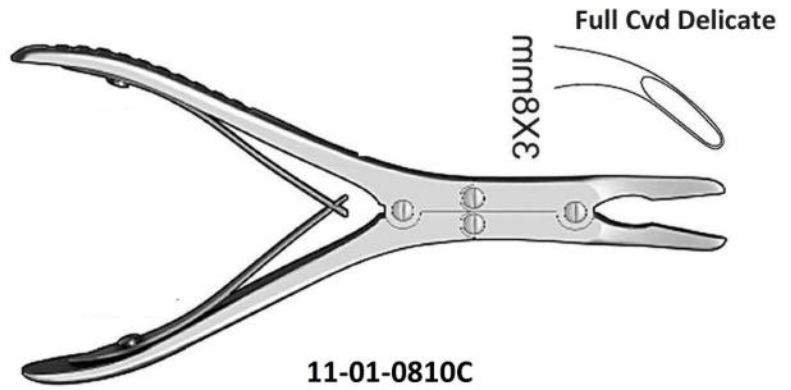

11-01-0810C

Kleinert Kurtz Synovectomy Rongeur 15 cm / 6"



11-01-0811

Semb Bone Rongeur 23.5 cm / 9 1/4"



11-01-0812

Stille Ruskin Bone Rongeur
23.5 cm / 9 1/4"

BONGE RONGEURS - NIBBLERS

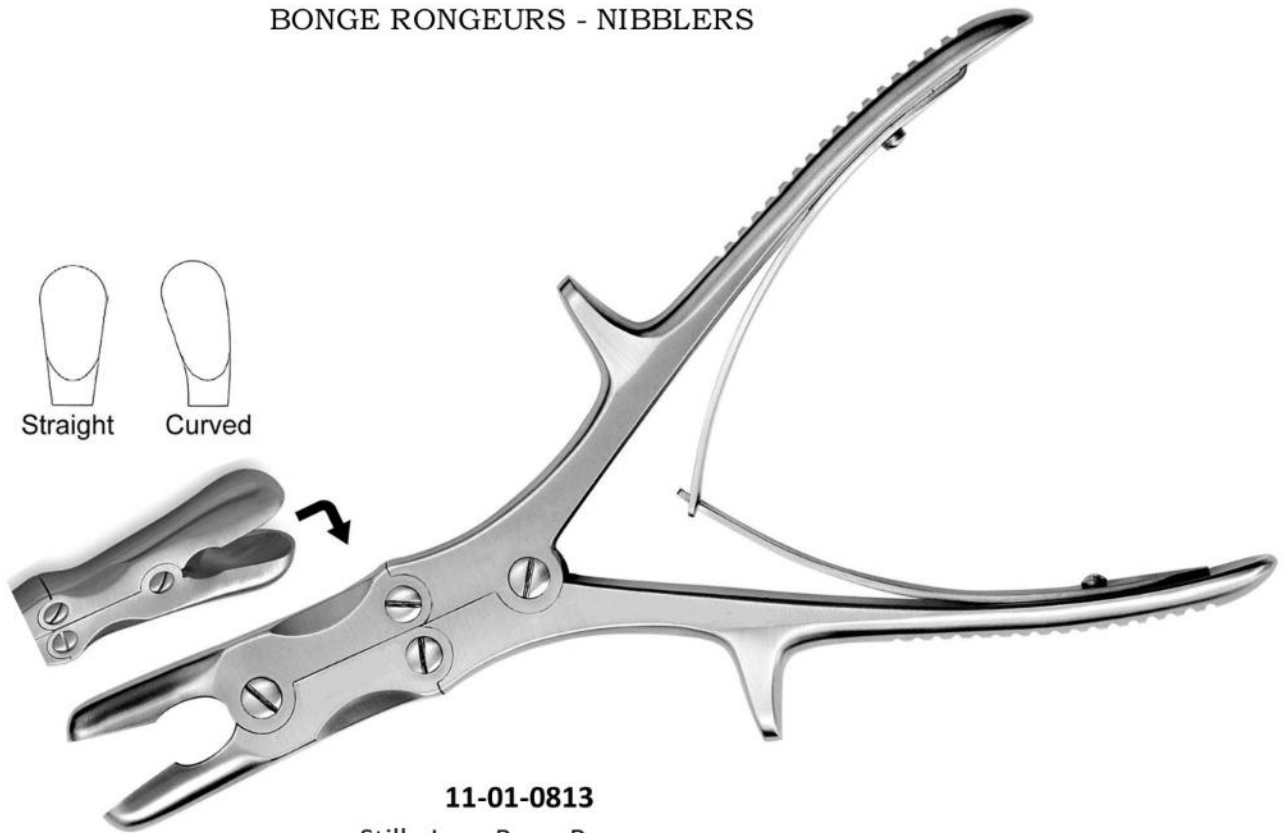

11-01-0813

Stille Luer Bone Rongeur
26.5 cm / 10 ½"

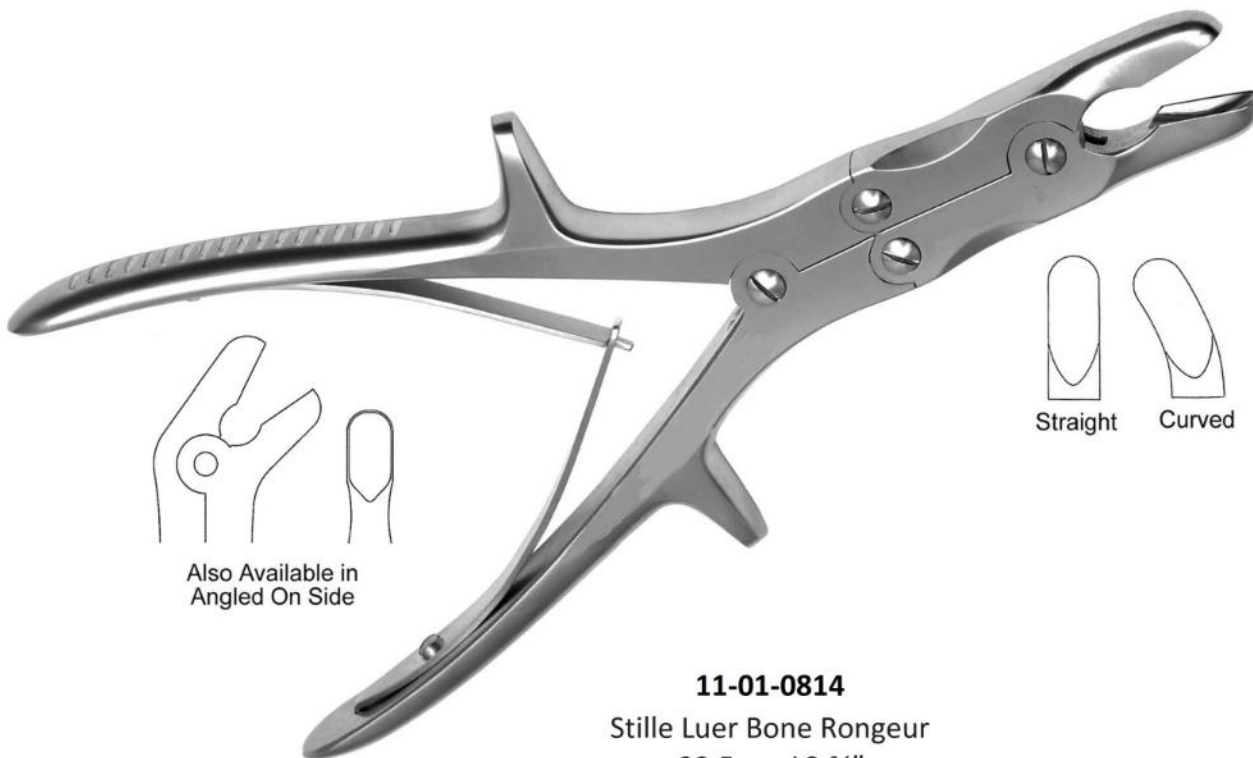

11-01-0814

Stille Luer Bone Rongeur
22.5 cm / 8 ¾"



11-01-0815
Mainz Long Neck Bone Rongeur
18 cm / 7"



11-01-0816
Leksell Bayonet Rongeur
41 cm / 16"

A: 3mm
B: 5mm
C: 8mm

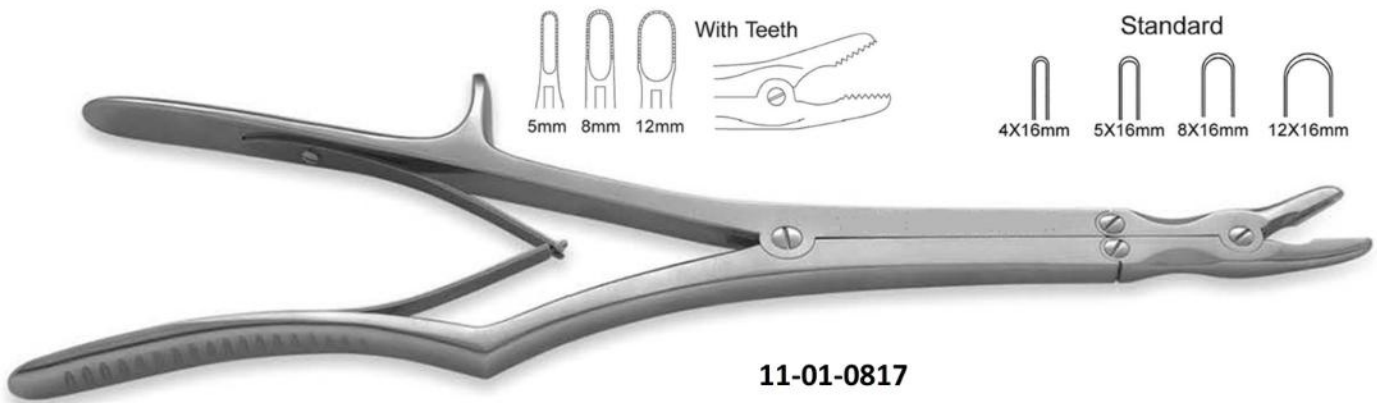

11-01-0817
Sypert Rongeur 37 cm / 14 1/2"

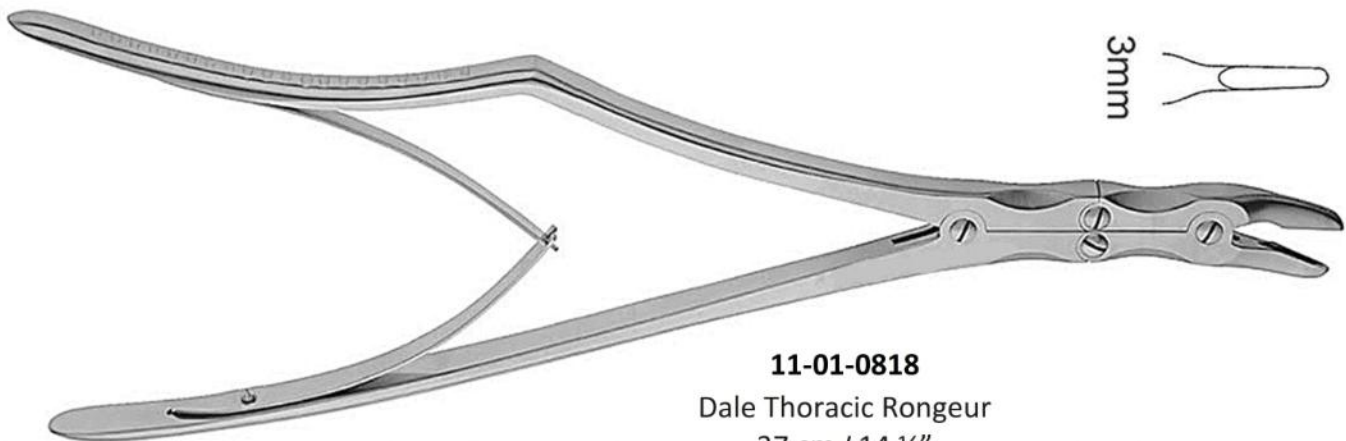

11-01-0818
Dale Thoracic Rongeur
37 cm / 14 1/2"

BONGE RONGEURS - NIBBLERS

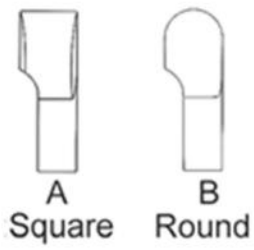
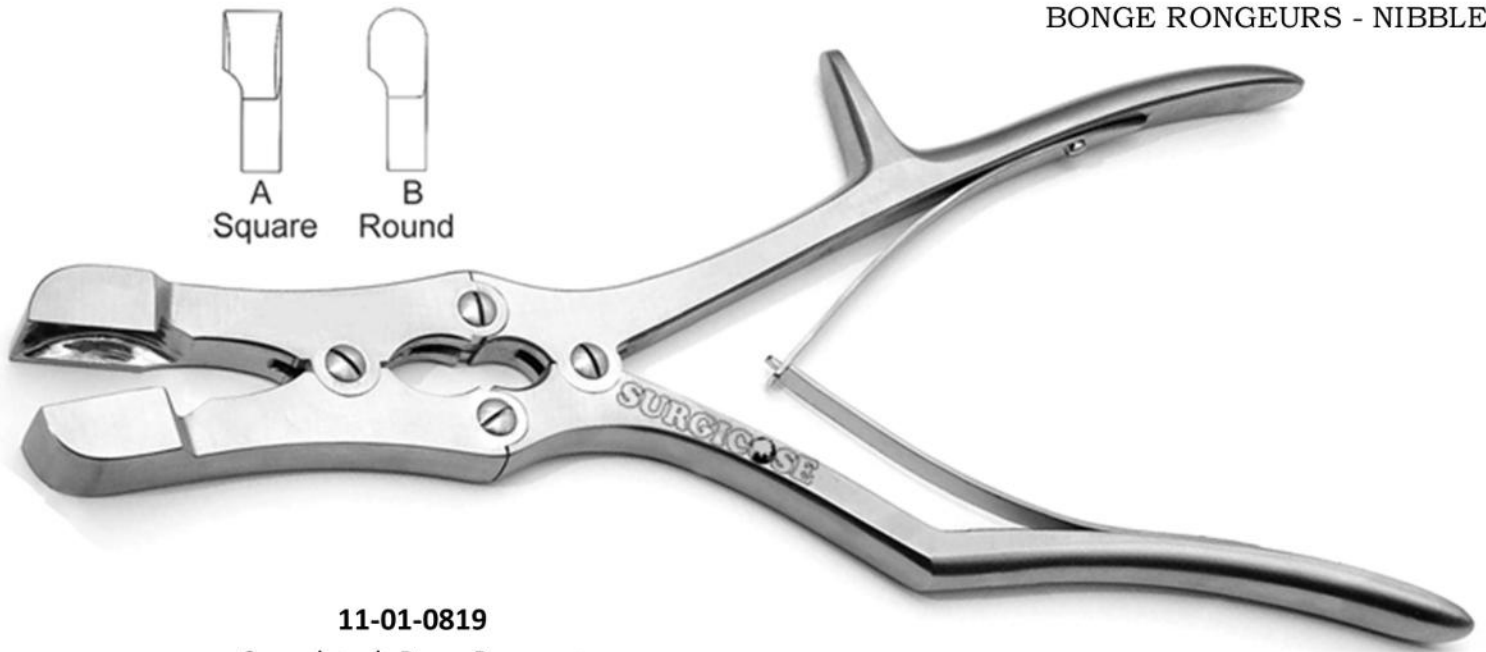

11-01-0819

Sauerbruch Bone Rongeur
37 cm / 14 ½"

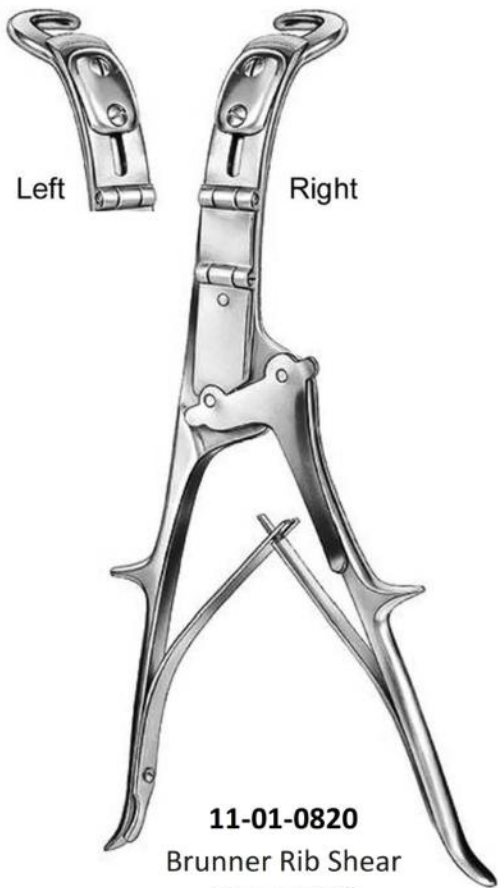

11-01-0820

Brunner Rib Shear
28 cm / 11"



11-01-0821

Sauerbruch Rib Shear
A: 23 cm / 9" | B: 26 cm / 10 ¼"

RIB SHEARS



11-01-0822
Giertz Stille Rib Shear
25 cm / 10"



11-01-0823
Rib Shear Double Spring 22 cm / 8 3/4"

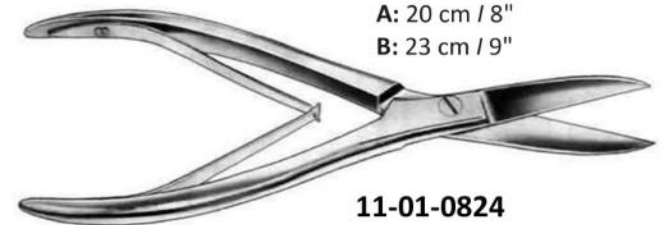

A: 20 cm / 8"
B: 23 cm / 9"
11-01-0824
Rib Shear Double Spring



11-01-0825
Collin Rib Shear 17.5 cm / 7"



11-01-0826
Collin Rib Shear 17 cm / 6 3/4"



11-01-0828
Gluck Rib Shear
A: 16 cm / 6"
B: 18 cm / 7"
C: 20 cm / 8"
D: 23 cm / 9"



11-01-0827
Stille Rib Shear 21 cm / 8 1/4"

RIB SHEARS

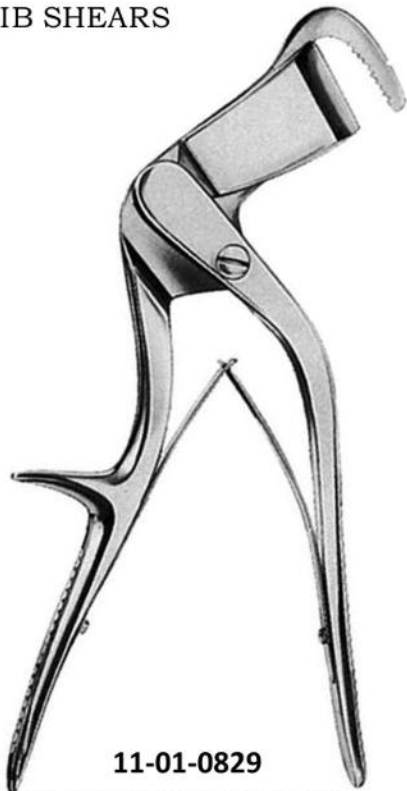

11-01-0829
Labsche Rib Shear 25 cm / 10"

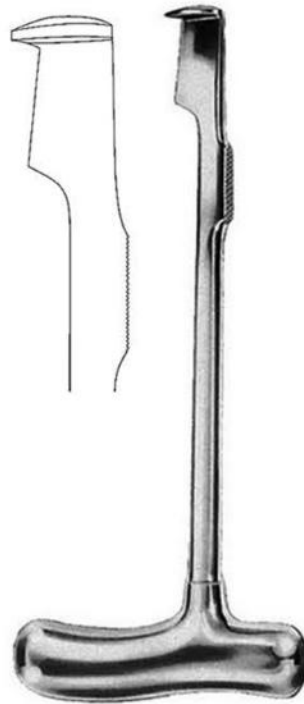

11-01-0830
T Handle Labsehe Sternum Chisel
24 cm / 9 1/2"



11-01-0831
Rib Shear Sideward 17 cm / 6 3/4"

Pointed
Tips



11-01-0832B
Bethune Rib Shear
S Shaped Handle
34 cm / 13 1/2"

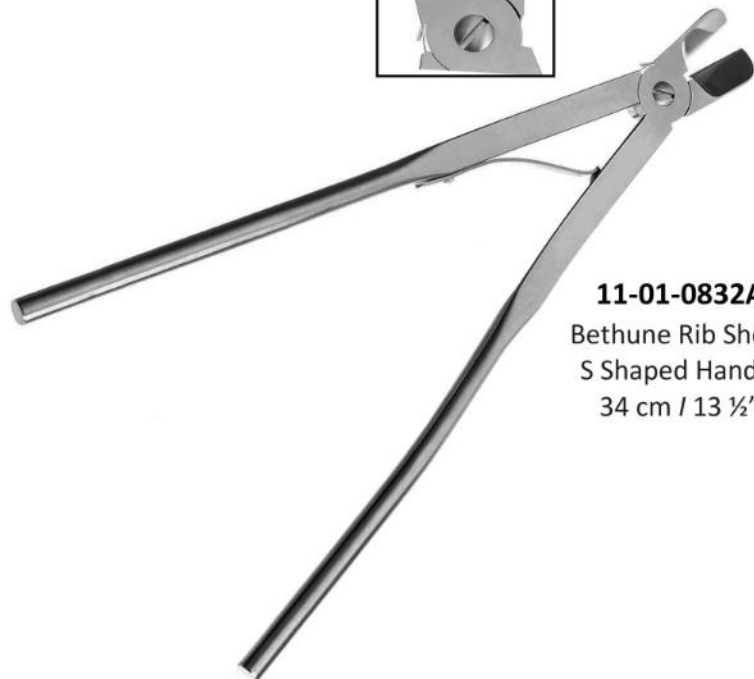

11-01-0832A
Bethune Rib Shear
S Shaped Handle
34 cm / 13 1/2"

RIB SHEARS



LAMINA SPREADERS - RETRACTORS

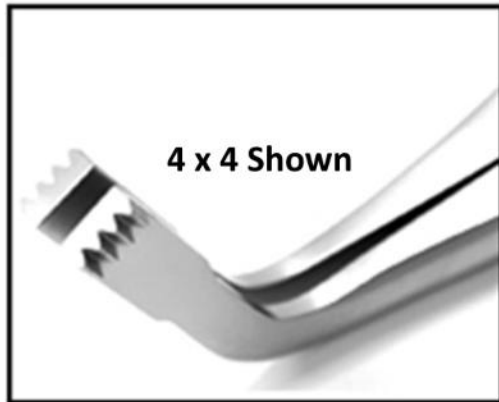

11-01-0835
INGE Spreader / Retractor

Available in 4X4 and 6X6 Teeth
& Without Teeth (Plain)



A: 4X4 Teeth
B: Without Teeth
16.5 cm / 6 ½"

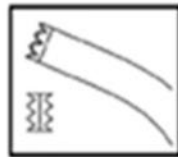

C: 4X4 Teeth
D: Without Teeth
25.5 cm / 10"



10 Inch Length Pattern

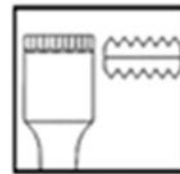

A: 6X6 Teeth
B: Without Teeth
27 cm / 10 ½"
Flat Blades



C: 6X6 Teeth
D: Without Teeth
27 cm / 10 ½"
Concave Blades



11-01-0836-1
Offset Lamina Spreader / Retractor
25.5 cm / 10"

LAMINA SPREADERS - RETRACTORS

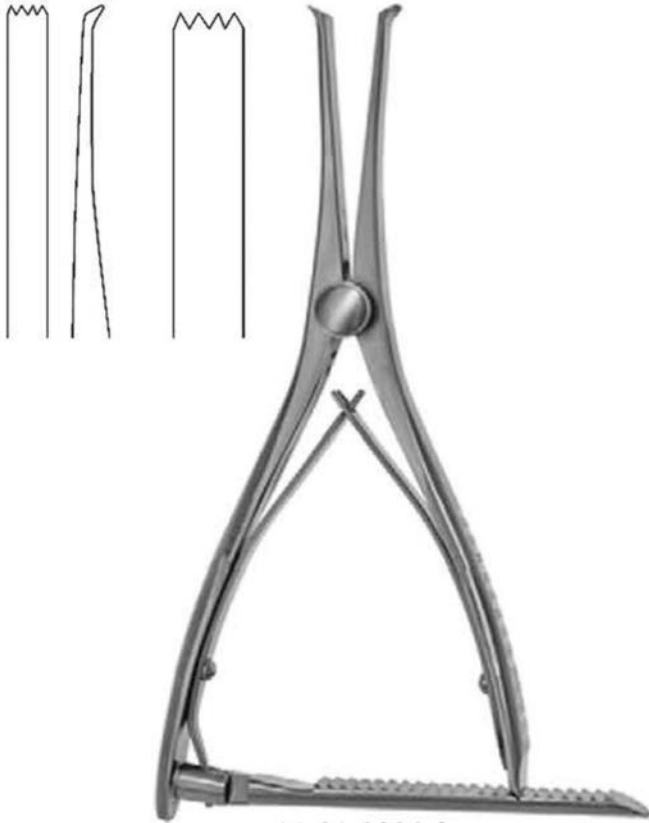

11-01-0836-2

Vertibra Spreader / Retractor
A: 18 cm / 7" | B: 28 cm / 11"



11-01-0837

Inge Spreader
Serrated Outside Blades 18 cm / 7"



11-01-0838

Saxsena Lamina Spreader / Retractor
A: 18 cm / 7" | B: 25.5 cm / 10"
Serrated Outside Blades

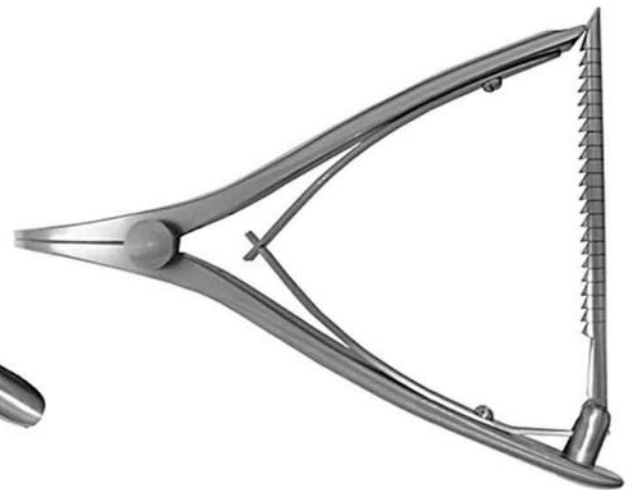

CALCANEAL – LAMBARDI SPREADERS



11-01-0839

Calcaneal Spreader
Smooth Pads 15X12mm
18 cm / 7"



11-01-0840

Calcaneal Spreader
Grooved Pads 15X12mm
18 cm / 7"



11-01-0841

Lombardi Femoral Tibial Spreader (Small)
A: Grooved Pads 22X13mm 18 cm / 7"
B: Diamond Cut Pads 22x13mm / 7"



B: Diamond Cut Pads 22X13mm



B: Diamond Cut Pads 22X13mm



11-01-0842

Lombardi Femoral Tibial Spreader (Large)
A: Grooved Pads 22X13mm 23.5 cm / 9 ¼"
B: Diamond Cut Pads 22x13mm / 9 ¼"

COMPRESSORS - DISTRACTORS



11-01-0843
Distracting Forceps 23 cm / 9"
Long Ratchet / Spiral Spring
For Screws and Rods



11-01-0844
Compressing Forceps 28 cm / 11"
Adjustable Locking
For Screws and Rods

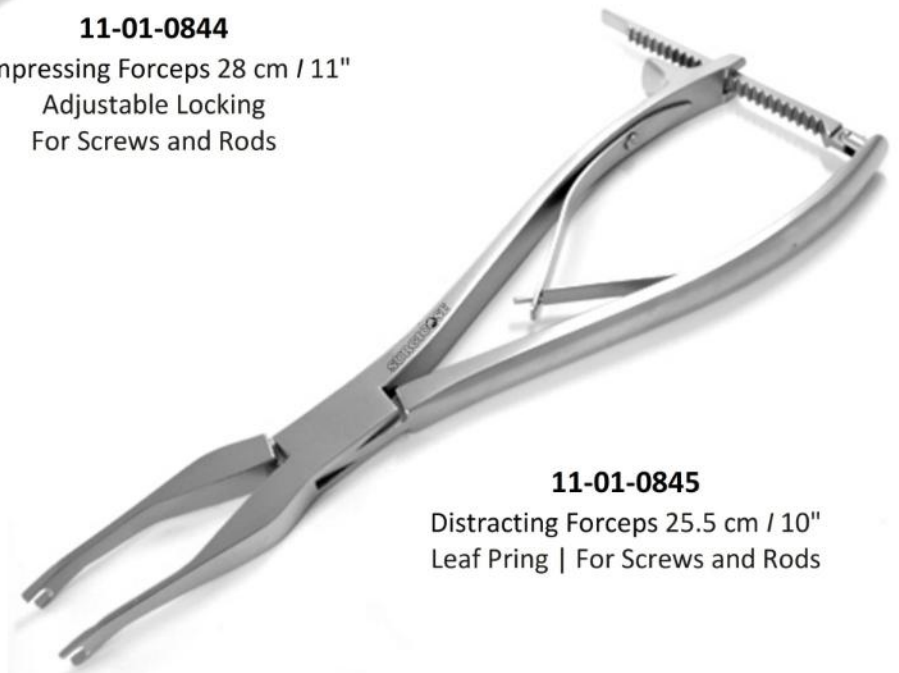

11-01-0845
Distracting Forceps 25.5 cm / 10"
Leaf Spring | For Screws and Rods

COMPRESSORS - DISTRACTORS



11-01-0846
Distractor 25.5 cm / 10"
Leaf Pring | For Screws and Rods



11-01-0847
Compression Forceps
28 cm / 11"
Leaf Pring / Long Ratchet
For Screws and Rods

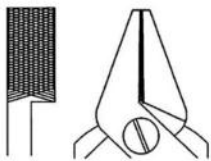

Non TC



11-01-0848
Jet Wire Twisting Device
28 cm / 11" - 10mm Tip

ROD BENDERS

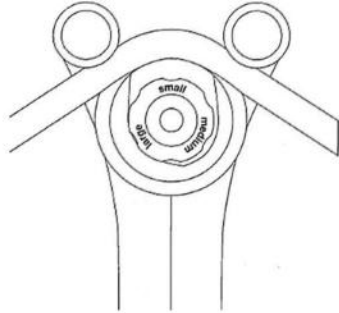

11-01-0849
French Style Rod Bender
28 cm / 11" | Roller Type
For Small / Medium / Large Bends

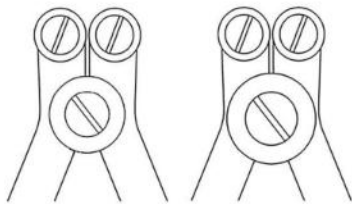

For 4mm Rod

For 3mm Rod



11-01-0850
One Hand Rod Bender | 19 cm / 7"
For 3 and 4 mm Diameter Rod

CARBIDE INSERTED WIRE – PIN CUTTING PLIERS

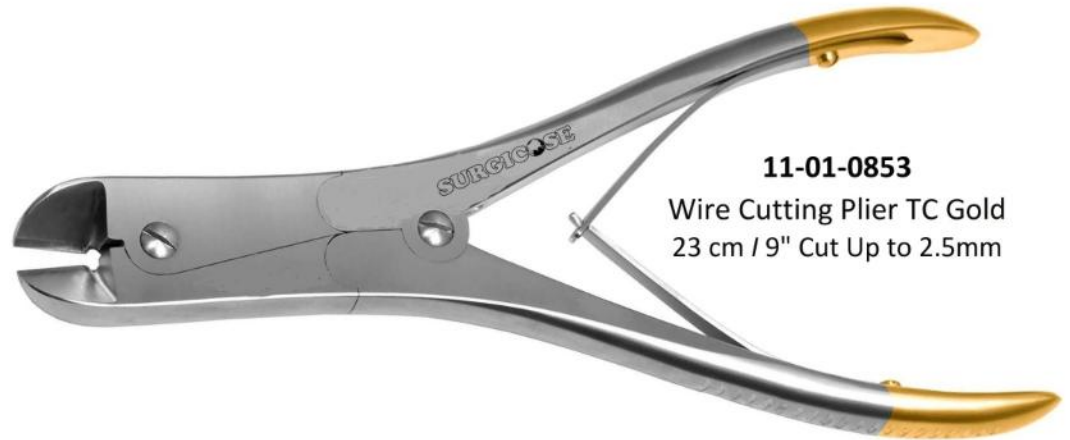
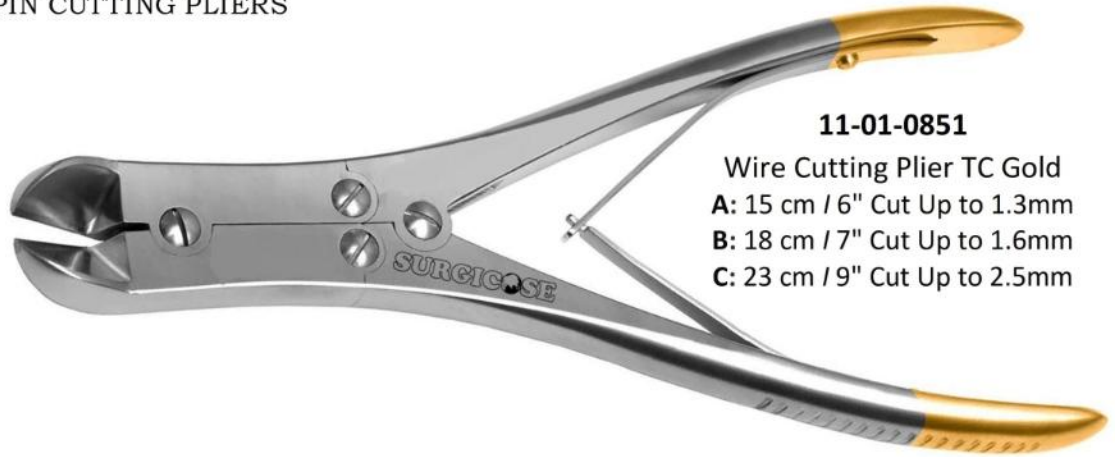
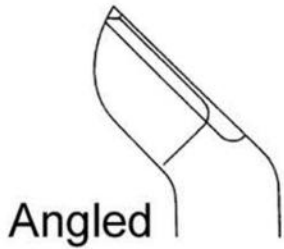

CARBIDE INSERTED WIRE – PIN CUTTING PLIERS



11-01-0855
Cannulated Pin Cutter TC Gold
18 cm / 7" Cut Up to 1.5mm



11-01-0856
Front End Wire Cutting Plier
TC Gold 15 cm / 6"
Cut Up to 1.3mm



11-01-0857
Front End Wire Cutting Plier
TC Gold 23 cm / 9"
Cut Up to 2.5mm



11-01-0858
Front End Wire Cutting Plier
TC Gold 23 cm / 9"
Cut Up to 2.5mm

CARBIDE INSERTED WIRE – PIN CUTTING PLIERS



11-01-0859
Plate / Pin Cutting Plier
TC Gold | 23 cm / 9"
Cut Up to 3.0mm

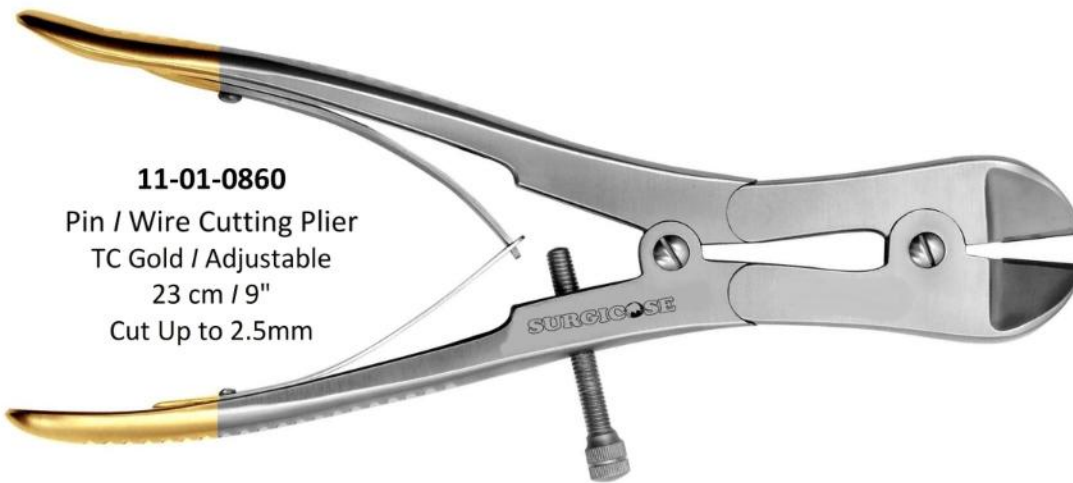

11-01-0860
Pin / Wire Cutting Plier
TC Gold / Adjustable
23 cm / 9"
Cut Up to 2.5mm

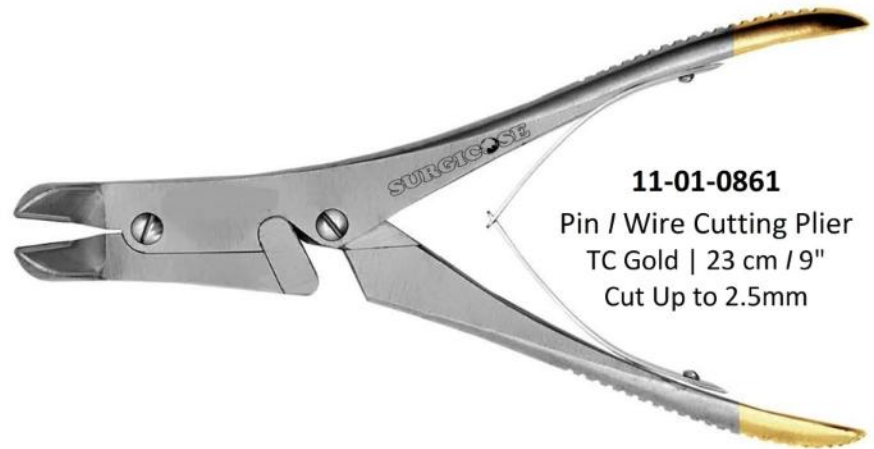

11-01-0861
Pin / Wire Cutting Plier
TC Gold | 23 cm / 9"
Cut Up to 2.5mm

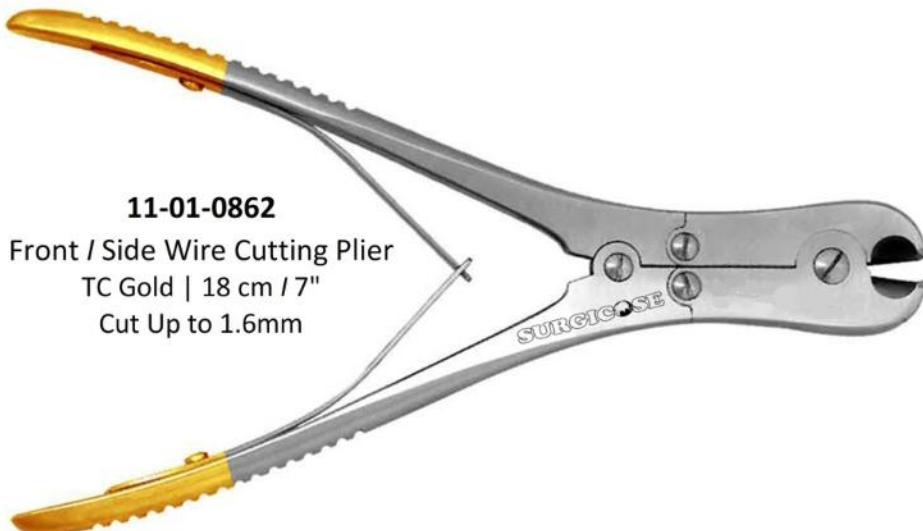

11-01-0862
Front / Side Wire Cutting Plier
TC Gold | 18 cm / 7"
Cut Up to 1.6mm

CARBIDE INSERTED WIRE – PIN CUTTING PLIERS



11-01-0863
Heavy Duty Pin Cutting Plier
TC Gold

- A: 30 cm / 12" Cut Up to 3mm
- B: 47 cm / 18 ½" Cut Up to 5mm
- C: 56 cm / 22" Cut Up to 6mm
- D: 60 cm / 24" Cut Up to 7mm



11-01-0864
Heavy Duty Pin End Cutting Plier TC Gold
A: 27 cm / 10 ½" Cut Up to 3mm
B: 38 cm / 15" Cut Up to 4mm

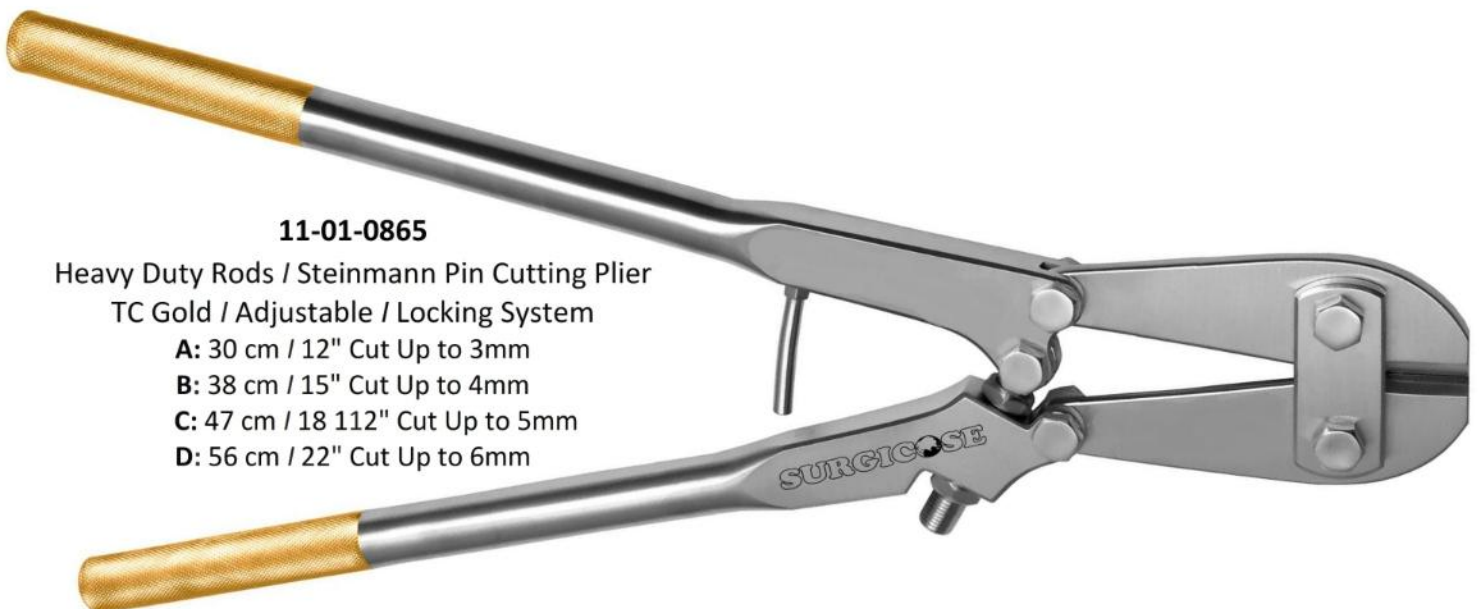

11-01-0865
Heavy Duty Rods / Steinmann Pin Cutting Plier
TC Gold / Adjustable / Locking System

- A: 30 cm / 12" Cut Up to 3mm
- B: 38 cm / 15" Cut Up to 4mm
- C: 47 cm / 18 1/2" Cut Up to 5mm
- D: 56 cm / 22" Cut Up to 6mm

CARBIDE INSERTED SURGICAL SCISSORS

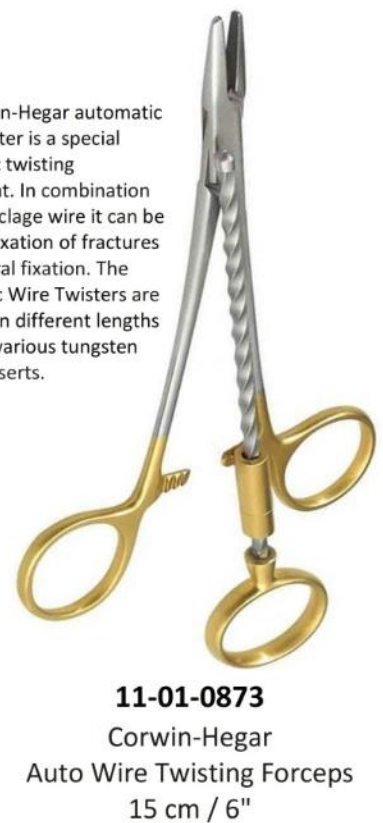
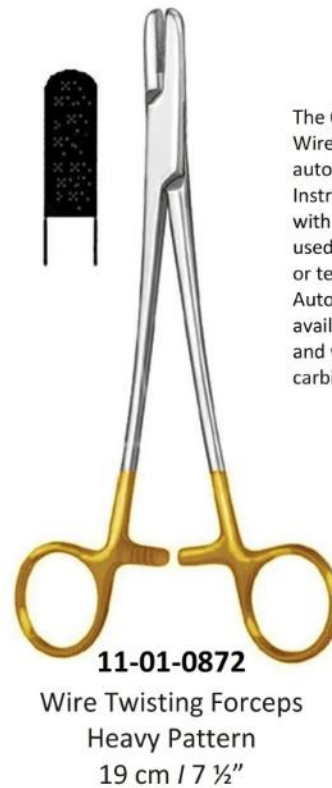
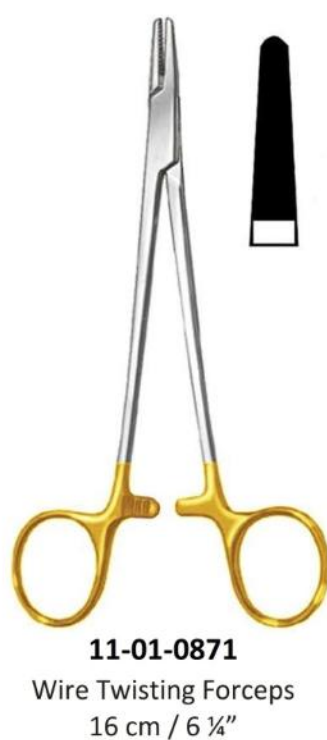

The Corwin-Hegar automatic Wire Twister is a special automatic twisting Instrument. In combination with a cerclage wire it can be used for fixation of fractures or temporal fixation. The Automatic Wire Twisters are available in different lengths and with various tungsten carbide inserts.

CARBIDE INSERTED SURGICAL SCISSORS

Blunt / Blunt

- A: 14.5 cm / 5 ¾" Str or Cvd
- B: 17 cm / 6 ¾" Str or Cvd
- C: 23 cm / 9" Str or Cvd



11-01-0874
Mayo Scissors TC Gold

- Sharp / Sharp
Cvd or Str
- Blunt / Blunt
Cvd or Str
- Sharp / Blunt
Cvd or Str

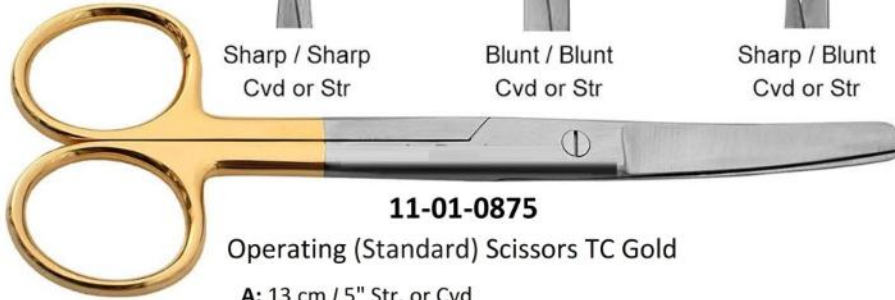

11-01-0875
Operating (Standard) Scissors TC Gold

- A: 13 cm / 5" Str. or Cvd
- B: 14 cm / 5 1/2" Str. or Cvd
- C: 15.5 cm / 6 1/2" Str. or Cvd
- D: 18 cm / 7" Str. or Cvd

Blunt / Blunt

- A: 14.5 cm / 5 ¾" Str. or Cvd.
- B: 17 cm / 6 ¾" Str. or Cvd.
- C: 23 cm / 9" Str. or Cvd.

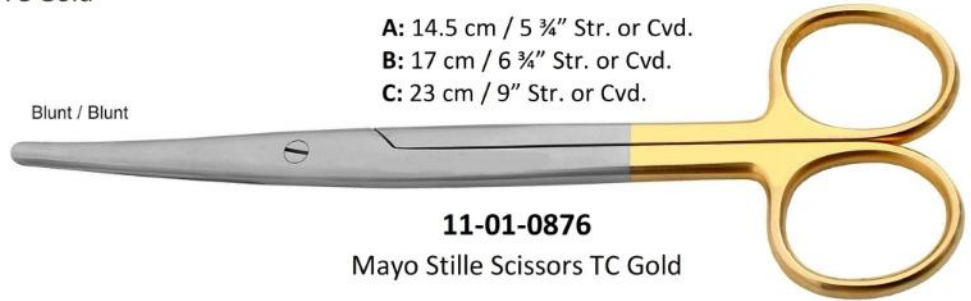

11-01-0876
Mayo Stille Scissors TC Gold

- A: 14 cm / 5 ½" Str. or Cvd
- B: 17 cm / 6 ¾" Str. or Cvd
- C: 20 cm / 8" Str. or Cvd
- D: 23 cm / 9" Str. or Cvd

Blunt / Blunt

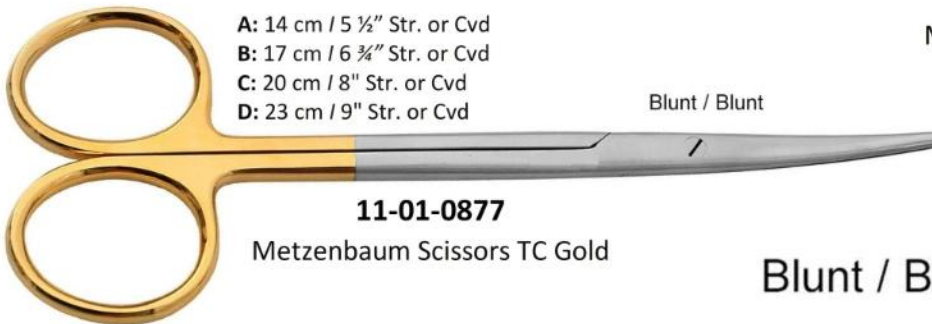

11-01-0877
Metzenbaum Scissors TC Gold

Blunt / Blunt

- A: 20 cm / 8" Str. or Cvd
- B: 23 cm / 9" Str. or Cvd
- C: 28 cm / 11" Str. or Cvd
- D: 30 cm / 12" Str. or Cvd



11-01-0878
Mayo-Harrington Scissors TC Gold

11-01-0879

Ortho Universal Scissors TC Gold
12 cm / 4 1/3"



11-01-0880

Mayo-Nobel Scissors TC Gold
16.5 cm / 6 ½" Str. or Cvd



INSTRUMENTS FOR TRUAMATOLOGY



Drill Bits for Quick Coupling

Drill bit 1.1mm dia.
for threaded hole for 1.5mm screws

Drill bit 1.5mm dia.
For threaded hole for 2.0mm screws and gliding hole for 1.5mm
Screws

Drill bit 2.0mm dia.
For threaded hole for 2.7mm dia.
For gliding hole for 2.7mm screws

Item	Diameter	Total length	Usable length
100.001	1.1mm	060mm	035mm
100.002	1.5mm	085mm	060mm
100.003	1.5mm	110mm	085mm
100.004	2.0mm	100mm	145mm
100.005	2.0mm	125mm	100mm
100.006	2.7mm	100mm	075mm
100.007	2.7mm	125mm	100mm
100.008	2.7mm	100mm	075mm
100.009	2.0mm	125mm	100mm

Drill bit 2.5mm dia.
For threaded hole for 3.5 and 4.0mm screws
Drill bit 3.5mm
for gliding hole for 3.5mm screws

Item	Diameter	Total length	Usable length
100.010	2.5mm	110mm	085mm
100.011	2.5mm	180mm	155mm
100.012	3.5mm	100mm	085mm
100.013	3.5mm	195mm	170mm

Drill bit 3.2mm dia.
For threaded hole for 4.5 and 6.5mm screws
Drill bit 4.5mm dia.
For gliding hole for 4.5mm screws

Item	Diameter	Total length	Usable length
100.014	2.0mm	100mm	145mm
100.015	3.2mm	225mm	200mm
100.016	3.2mm	145mm	120mm
100.017	3.2mm	195mm	170mm
100.018	4.5mm	145mm	120mm
100.019	4.5mm	195mm	170mm



Drill Bit for Jacobs chuck

Item	Diameter	Total length	Usable length
101.001	1.1mm	45mm	30mm
101.002	1.5mm	70mm	55mm
101.003	2.0mm	85mm	70mm
101.004	2.5mm	95mm	80mm
101.005	2.7mm	85mm	70mm
101.006	3.2mm	130mm	115mm
101.007	3.2mm	180mm	165mm
101.008	3.5mm	95mm	80mm
101.009	3.5mm	180mm	165mm
101.010	4.5mm	130mm	115mm
101.011	4.5mm	180mm	165mm



11-01-0881

Tap for 1.5mm Cortex Screws
Total length 50mm, thread length 20mm
predrilling 1.1mm dia.



11-01-0882

Tap for 6.5mm Cancellous Bone Screws
Length 195mm, predrilling 3.2mm dia.



11-01-0883

Tap for 4.0mm Cancellous Bone Screws
Total Length 110mm, Usable Length 85mm



11-01-0884

Tap Cannulated, for 7.0mm Cannulated Screws
Length 230mm

INSTRUMENTS FOR TRUAMATOLOGY



Tap for 2.0mm Cortex Screws
Predrilling: 1.5mm dia.

Tap for 2.7mm Cortex Screws
Predrilling: 2.0mm dia.

Item	Thread	length
102.001	24mm	053mm
102.002	38mm	100mm

Item	Thread length	Total length
102.005	33mm	100mm
102.006	40mm	150mm

Tap for 3.5mm Cortex Screws
Predrilling: 2.5mm dia.

Item	Total length	Type
102.007	175mm	with length markings
102.008	110mm	thread length 50mm

Predrilling: 3.2mm

Item	Length	Type
102.003	125mm	thread length 70mm
102.004	175mm	with length markings

102.009

Tap for 3.5mm Cortex Screws
Total Length: 110mm
Thread Length: 50mm
Predrilling: 3.2mm dia.

102.010

Tap for 2.7mm Cortex Screws
Total length: 125mm
Thread length: 40mm
Predrilling: 2.0mm dia.

102.011

Tap for 4.5mm Cortex Screws
Total length: 125mm
Thread length: 70mm
Predrilling: 3.2mm dia.



11-01-0885

Countersink Shaft 1.5/2.0
Length 52mm, for mini quick coupling



11-01-0886

Router, for Jacobs chuck
Length 90mm



11-01-0887

Router, for quick coupling
Length 90mm



11-01-0888

Countersink Shaft 3.5mm
Length 72mm, for quick coupling,
to countersink the screw head



11-01-0889

Countersink, large
Length 180mm, for 4.5mm cortex screws



11-01-0890

Dountersink, cannulated, for 7.0mm cannulated Screws
Length 230mm

INSTRUMENTS FOR TRUAMATOLOGY



11-01-0891

Screwdriver Shaft, hexagonal, small
Length 100mm, for quick coupling
For 2.7 to 4.0mm screws.



11-01-0892

Screwdriver Shaft, Hexagonal, large
Length 100mm, final tightening of the screw has to be done by hand.



11-01-0893

Screwdriver Shaft, hexagonal, with Holding Sleeve
For 1.5 and 2.0mm stainless steel screws
With hexagonal socket,



11-01-0894

Screwdriver Shaft, cruciform, 1.5/ 2.0, with Holding Sleeve
Length 50mm, for 1.5 and 2.0mm



11-01-0895

T-Handle with Coupling
Length: 80mm, for taps



11-01-0896

Screwdriver, hexagonal, with T-Handle,
Large to loosen tight screws.
A normal screwdriver can be additionally inserted in the hollow shaft of the T-handle.



11-01-0897

Handle with mini quick coupling



11-01-0898

Hand Chuck for Kirschner Wires
Length 145mm, Spannbereich 0.6 to 1.6mm dia.



11-01-0899

Handle with quick coupling
Length 110mm, for countersinks and
Instruments for the removal of damaged screws



11-01-0900

Handle, small, with mini quick coupling

INSTRUMENTS FOR TRUAMATOLOGY



11-01-0901

Handle, medium, with mini quick coupling



11-01-0902

Handle, Large, with mini quick coupling



11-01-0903

Screwdriver, hexagonal, small with groove
Length 200mm, for 2.7 to 4.0mm screws



11-01-0904

Screwdriver with Universal Joint, large
Length 290mm



11-01-0905

Screwdriver, hexagonal, large, with groove
Length 240mm



11-01-0906

Screwdriver, hexagonal, with Holding Sleeve,
Length 165mm for 1.5 and 2.0mm stainless
Steel screws with hexagonal socket



11-01-0907

Screwdriver, hexagonal, small, with Holding Sleeve
Length 200mm



11-01-0908

Holding Sleeve for Mini Screws single



11-01-0909

Holding Sleeve



11-01-0910

Holding Sleeve single



11-01-0911

Allen Key, hexagonal, angled
For 4.5 to 7.0mm screws



11-01-0912

Allen Key, hexagonal, small, angled
Length 65mm, for 2.7 to 4.0mm screws

INSTRUMENTS FOR TRUAMATOLOGY



11-01-0913

Insert Drill Sleeve 3.5/2.5
Length 42mm, drill bit 2.5mm dia.



11-01-0914

Insert Drill Sleeve 4.5/3.2
Length 80mm for long lag screws



11-01-0915

Trocar 2.0mm dia., Length 118mm, for percutaneous insertion of 7.0mm cannulated screws



11-01-0917

Drill Sleeve 8.0/4.5
Length 100mm, for percutaneous insertion of 7.0mm cannulated screws



11-01-0916

Drill Sleeve 4.5/ 2.0
Length 109mm, for percutaneous insertion of 7.0mm cannulated screws



11-01-0920

Handle for Drill Guides single



11-01-0918

Handle for Drill Guides single



11-01-0921

Drill Sleeve 1.5mm / 2.0 / 2.7mm



11-01-0919

Drill Sleeve 3.0 with point length 55mm

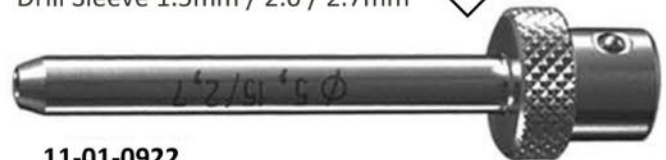

11-01-0922

Drill Sleeve 2.7



11-01-0923

Double Drill Sleeve 1.5/101
For 1.5mm cortex screws
Drill bits, 1.5 and 1.1mm dia.



11-01-0924

Double Drill Sleeve 2.0/1.5 for
2.7mm cortex screw



11-01-0925

Double Drill Sleeve 2.7/2.0
For 2.7mm cortex screws



11-01-0926

Double Drill Sleeve 3.5/2.5
For 3.5mm cortex screws and 4.0mm cancellous bone screws
Drill bits 3.5 and 2.5 dia.,

INSTRUMENTS FOR TRUAMATOLOGY



11-01-0927

Double Drill Sleeve 4.5/3.2
For 4.5mm cortex screws
Drill bits: 4.5 and 3.2mm dia.



11-01-0928

Double Drill Sleeve 6.5/3.2
For 6.5mm cancellous bone screws
Drill bit: 3.2mm dia.



11-01-0929

Universal Drill Sleeve 2.7
Drill bits 2.0 and 2.7mm dia.,
Suitable for LC-DCP and round hole plates.



11-01-0930

Universal Drill Guide 3.5
Drill bit 2.5 and 3.5mm dia., and tissue protection
Suitable for LC-DCP and round hole plates.



11-01-0931

Universal Drill Guide 4.5/3.2
Drill bits 3.2 and 4.5mm dia.



11-01-0932

DCP Drill Guide 2.0
For neutral and load position
Drill bit 1.5mm dia.



11-01-0933

DCP Drill Guide 2.7
For neutral and load position
Drill bit 2.0mm dia.



11-01-0934

DCP Drill Guide 3.5
For neutral a load position, drill bit 2.5mm
dia.



11-01-0935

DCP Drill Guide 4.5
For neutral and load position, drill bit
3.2mm dia.



11-01-0936

LC-DCP Drill Guide 3.5
For neutral a load position, drill bit 2.5mm dia.



11-01-0937

LC-DCP Drill Guide 4.5
For neutral and load position, drill bit 3.2mm dia.



11-01-0938

DCP Hip Drill Guide 4.5, for neutral
and load position, for 4.5mm screws
with DHS and angled blade plates, sleeve
length 60mm, drill bit 3.2mm dia.

INSTRUMENTS FOR TRUAMATOLOGY



11-01-0939
Triple Drill Sleeve 2.0
with 3 holes, opposite side 1 hole

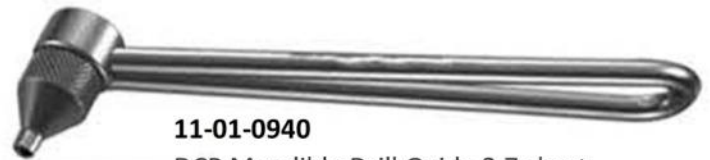

11-01-0940
DCP Mandible Drill Guide 2.7 short
drill bit 2.0mm dia.



11-01-0941
DCP Mandible Drill Guide 2.7 long
drill bit 2.0mm dia.



11-01-0942
Insert Drill Sleeve with stop, for 4.5mm screws
adjustable length to limit drilling depth,
external dia. 4.5mm for drill bits of 3.2mm dia.



11-01-0943
Parallel drill Guide 4.5
For percutaneous insertion of 7.0mm cannulated screws



11-01-0944
Parallel Wire Guide 2.0mm dia.



11-01-0945
Depth Gauge for 2.7 to 4.0m screws
measuring range up to 60mm



11-01-0948
Bending Iron for plates 2.7 and 3.5
Length 150mm, slid widths 2.5 and 4.5mm, required paris
Slid placement: 4.5 / 2.5
Slid placement: 2.5/4.5



11-01-0946
Depth Gauge for 2.7 to 4.0mm screws measuring
range up to 60mm



11-01-0947
Depth Gauge for 4.5mm to 6.5mm screws measuring
range up to 110mm



11-01-0949-1
Bending Iron for plates 1.5 and 2.5
Length: 130mm, slid width: 2.5mm

INSTRUMENTS FOR TRUAMATOLOGY

11-01-0949-2

Triple Drill Guide

130° angle, for 130° angled blade plates and for condylar plates, drill bit 4.5mm dia.



11-01-0950

Drill Guide with stop 3.5/2.7 to limit drilling depth



11-01-0951

Protection Sleeve 11.0/8.0 for percutaneous insertion of 7.0mm cannulated screws



11-01-0952

Holding Sleeve
Length 80mm, for 2.7 to 4.0mm screws



11-01-0953

Holding Sleeve for length 80mm for 2.7mm screws and 3.5mm cannulated screws



11-01-0955

Screw Forceps, self-holding
Length 85mm, to take screws out of the screw racks



11-01-0954

Holding Sleeve, large, length 120mm



11-01-0956

Drill Sleeve, pointed



11-01-0957

Bending Iron LC-DCP/DCP
Length 250mm, for small and broad LC-DCP, DCP
Slit widths 5 and 7mm, required in pairs

INSTRUMENTS FOR TRUAMATOLOGY



11-01-0958
Bending Iron for Kirschner Wires
Length 120mm, for 1.25 to 2.5mm dia.



11-01-0959
Bending Iron for Kirschner Wires
Length 115mm, for 0.8 to 1.25mm dia.



11-01-0960
Bending Iron for Reconstruction Plates 3.5 and 4.5
Length 190mm, required in paris

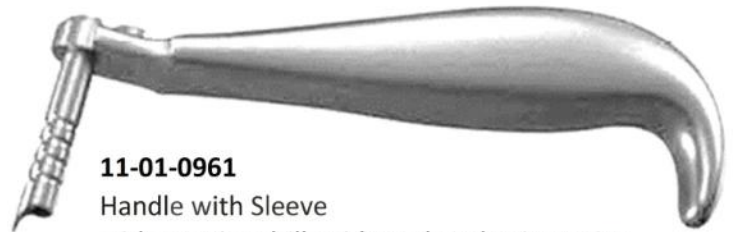

11-01-0961
Handle with Sleeve
with rotating drill guide and anchoring point



11-01-0962
Trocar Point, large



11-01-0964
Combination Wrench 11mm length 140mm



11-01-0963
Cheek Retractor Ring



11-01-0965
Pin Wrench, length 120mm, 4.5mm dia.
For tension device, distractor and knurled
nut of insertion handle for intramedullary nail



11-01-0966
Socket Wrench 11mm
Length 200mm



11-01-0967
Slotted Hammer
Length 270mm



11-01-0968
Inserter/Extractor, with Adjustable Clamps, length 270mm, for the
insertion and extraction of angled plates for adults and hip plates for
adolescents and children as well as tibial plateau osteotomy plates.



11-01-0969
Measuring Device
For drill bits, screws, Kirschner wires,
and Steinmann pins

INSTRUMENTS FOR TRUAMATOLOGY



11-01-0970

Inserter/Extractor
Length 175mm, for infant hip plate and mini hip plate.



11-01-0971

Bending Pliers for Reconstruction Plates 2.7 and 3.5
Length 240mm



11-01-0972

Bending Pliers for plate 2.4 to 4.0
Length 230mm



11-01-0973

Cutter for thin plates 1.5 to 2.7
Length 256mm



11-01-0974

Bending Pliers
For reconstruction plates 2.7,
Length 270mm, required in paris



11-01-0975

Cerclage Wire Tightener
Length 260mm
For twisting, for temporary fixation during reduction



11-01-0976

Bending Pliers for Plates

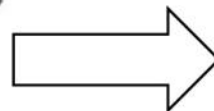

11-01-0977

Anvil, narrow



11-01-0978

Anvil, Large

INSTRUMENTS FOR TRUAMATOLOGY

11-01-0979

Bending Press
Length 400mm



11-01-0980

Tension Device, articulated
Span 20mm, can also be used as a distractor.
Color scale: yellow up to 500N, green up to 1000N, red above 100N.



11-01-0981

Chisel Guide
With adjustable angle



11-01-0983

Blade with foot single

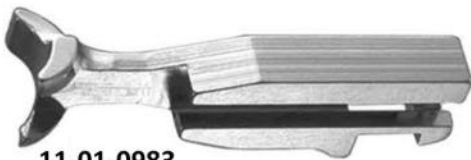

11-01-0984

Blade with tip single

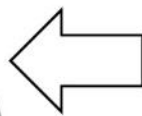
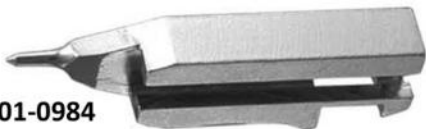

11-01-0982

Forceps with Sliding Blades
Complete with two interchangeable blades
Length 155mm, weight 42 g, speed lock

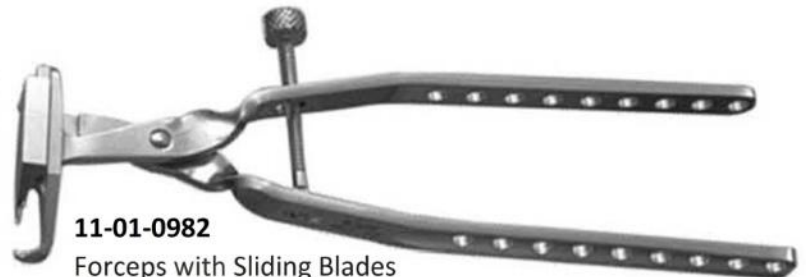

11-01-0985

Wire Passer 45mm bending diameter



11-01-0986

Wire Passer 70mm bending diameter



11-01-0987

Holding Clip



11-01-0988

Wire Tightener
Length 240mm, with handle and two pegs



INSTRUMENTS FOR TRUAMATOLOGY



11-01-0989

Handle with quick coupling
Length 150 mm



11-01-0990

Cancellous Bone Impactor, curved, 6mm dia.
Length 140 mm



11-01-0991

Cancellous Bone Impactor, curved, 6mm dia.
Flattened, Length 140 mm



11-01-0992

Cancellous Bone Impactor, straight, 8 mm dia.
Length 140 mm



11-01-0993

Cancellous Bone Impactor, rectangular,
6x16mm, Length 140 mm



11-01-0994

Cancellous Bone Impactor, rectangular,
10x20mm, Length 140mm



11-01-0995

Cancellous Bone Impactor, rectangular,
10x30mm, Length 140 mm



11-01-0996

Rasp round
Length: 140 mm



11-01-0997

Rasp, half-round
Length: 140 mm



11-01-0998

Gouge, straight, 5mm wide
Length 140 mm



11-01-0999

Gouge, curved, 5mm wide
Length 140 mm



11-01-1000

Gouge, straight, 10 mm wide
Length 140mm



11-01-1001

Gouge, curved, 10 mm wide
Length 140 mm



11-01-1002

Gouge, curved, 15 mm wide
Length 140 mm

INSTRUMENTS FOR TRUAMATOLOGY



11-01-1003

Gouge, straight, 15 mm wide
Length 140 mm



11-01-1004

Chisel, flat, curved, 16 mm wide
Length 140 mm



11-01-1005

Chisel, flat, straight, 16 mm wide
Length 140 mm



11-01-1006

Chisel, flat, curved, 4 mm wide
Length 140 mm



11-01-1007

Chisel, flat, 20 mm wide
Length 140 mm



11-01-1008

Chisel, flat, curved, 8 mm wide
Length 140 mm



TRYMAX SURGICAL



+92-321-7194104

info@trymaxsurgical.com

www.trymaxsurgical.com

Head Marala Road Near Machhi Khokhar, Sialkot - 51310 Pakistan.

